

**E Cassese®**

*Quality for the world*

**CS 79**



# **Technical and User Manual**

V1 - 07/99

Cassese / Communication

**FOOT OPERATED FRAME ASSEMBLING MACHINE**

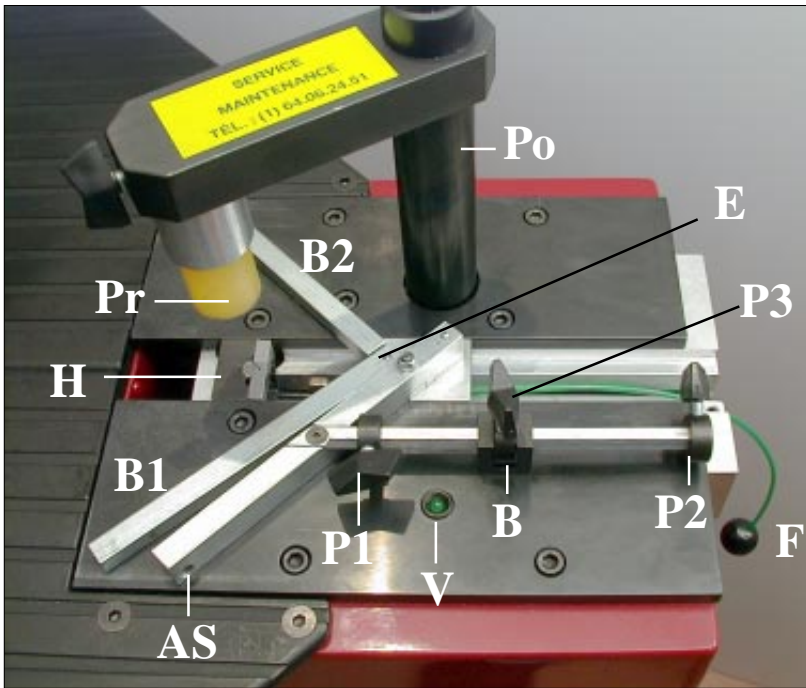

**Fig N°1**

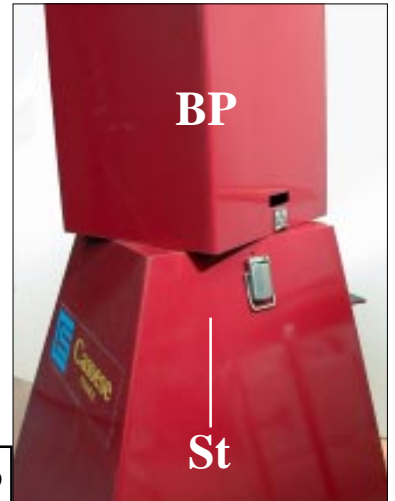

**Fig N°3**

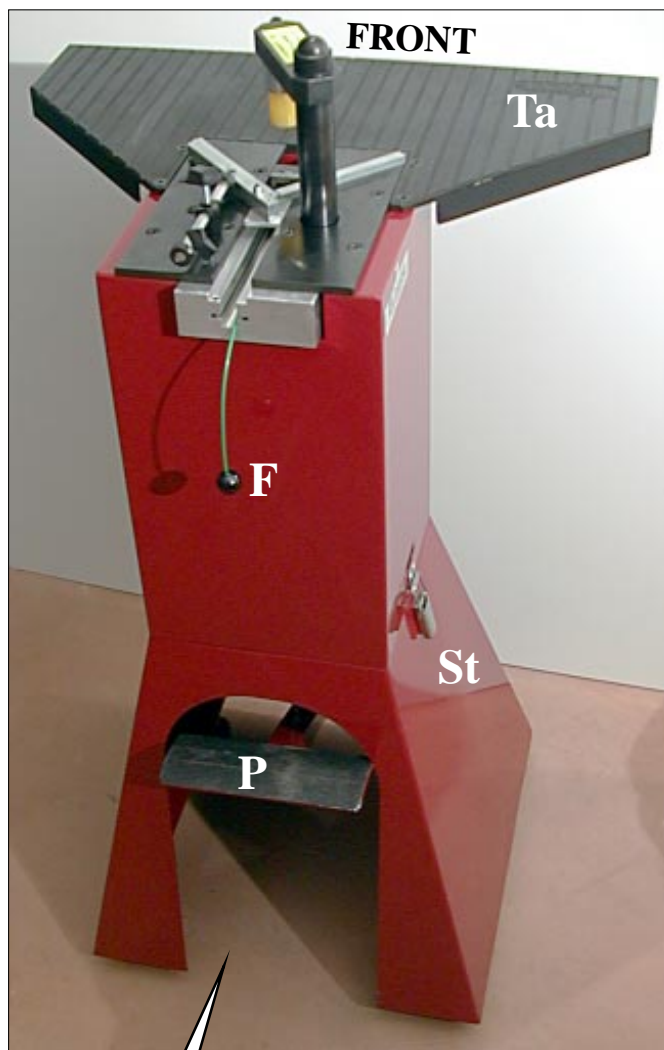

**Fig N°2**

**WORK POSITION REFERENCE**

ANGLE ADJUSTMENT SCREW	AS
LIMIT STOP	B
1 <sup>st</sup> BACKFENCE	B1
2 <sup>nd</sup> BACKFENCE	B2
ROTATING BASE CABINET	BP
90° JOINING ANGLE ASSEMBLY	E
WIRE FOR WEDGE PUSHING SPRING	F
WEDGE DISTRIBUTOR	H
LEVER FOR STAPLING POSITION (inside of frame)	P1
LEVER FOR STAPLING POSITION (outside of frame)	P2
LEVER FOR ONLY ONE OR INTERMEDIATE POSITIONS	P3
FOOT PEDAL	P
TOP PRESSER BRACKET	Po
TOP PRESSER	Pr
BASE CABINET LOCKERS	St
EXTENSION TABLE	Ta
WEDGE FULLY INSERTED INDICATOR LIGHT	V

# CS 79 - USER'S TECHNICAL MANUAL

## CONTENTS

## Page

<b>INTRODUCTION</b>	<b>2</b>
ACCESSORIES SUPPLIED WITH THE MACHINE	
TECHNICAL SPECIFICATIONS	
OPTIONS	
GUARANTEE	
<b>PUTTING INTO OPERATION</b>	<b>3,4</b>
REASSEMBLY	
<b>ADJUSTMENTS</b>	
SELECTION OF STAPLING POSITIONS	<b>5</b>
SETTING AND STORING THE STAPLING POSITIONS	<b>5,6</b>
SELECTION OF TOP PRESSER	<b>7</b>
ADJUSTMENT OF THE ASSEMBLY ANGLE	<b>7</b>
<b>NEW VERSION TOP PRESSER</b>	<b>12</b>
<b>USE</b>	
MEANS OF ASSEMBLY	<b>8</b>
LOADING THE WEDGE CARTRIDGE ON MACHINE	
JOINING THE FRAME	
<b>MAINTENANCE</b>	
LUBRICATION	<b>9</b>
CLEARING A WEDGE STUCK IN THE WEDGE DISTRIBUTOR	<b>10</b>
REPLACEMENT OF BATTERY	<b>11</b>

## INTRODUCTION

You have just bought a CS 79 frame joining machine, so we congratulate on your sensible choice and thank you for your trust in Cassese products.

The CS 79 benefits from the experience of the joining machines that brought Cassese a certain reputation. It makes it possible to join wooden mouldings of all profiles ( patent n° 7522814).

The CS 79 is designed to allow the operator to move all around the machine.

The joining operation is carried out by using metal wedges especially designed to perform a tight join. These wedges come in throw-away plastic cartridges, without glue, individually lubricated and rust-protected for the toughest challenges.

---

**IMPORTANT :** You should not use other wedge cartridges than those manufactured by Cassese and marketed by official Cassese distributors (registered mark CS).

### BEWARE OF COPIES.

---

### ACCESSORIES SUPPLIED WITH THE MACHINE

1 extra long support for triangle top presser with 1 black rubber triangle (for hardwoods) + 1 white triangle (softwoods)/ 1 spare hammer (wedge driver blade)  
4 Allen keys for hexagonal nuts (2,5 - 3 - 4 - 5 mm) / 1 wedge pusher tool /

### TECHNICAL SPECIFICATIONS OF CS 79

Minimum moulding width : 3mm (1/8") Minimum moulding height : 7 mm (1/4")

Furthest stapling position from back of moulding (at 45°) : 74 mm (3")

Wedge sizes in cartridges of 275 pieces : 3, 4, 5, 7, 10, 12 and 15 mm.

Two wedge types : for soft and for hardwoods.

Machine gross weight : 40 kg (85 lbs)

Dimensions : 507mm(20")x 507mm (20")(w/out extension table)x1100 mm high (44")

### OPTIONAL ACCESSORIES AVAILABLE

Cassese Item #	Description
Z 4511	120° Joining angle assembly (for 6-sided frames)
Z 4512	135° Joining angle assembly (for 8-sided frames)

### Other top pressers (See page 12 NEW VERSION TOP PRESSER) :

Cassese Item #	Description	For use on	Maxi moulding height
Z 4556	White Triangle with support	Soft wood	65 mm (2 1/2")
Z 887	Black Triangle with support	Hardwoods	65 mm (2 1/2")
Z 4558	Short orange rubber with support	Softwoods	69 mm (2 3/4")
Z 4559	Short green rubber with support	Hardwoods	69 mm (2 3/4")
Z 4560	Long orange rubber with support	Softwoods	54 mm (2 3/16")
Z 4561	Long green rubber with support	Hardwoods	54 mm (2 3/16")
Z 1800	Long orange rubber w/out support	Softwoods	83 mm (3 5/16")
Z 1804	Long green rubber w/out support	Hardwoods	83 mm (3 5/16")
Z 1783	Short orange rubber w/out support	Softwoods	98 mm (3 7/8")
Z 1791	Short green rubber w/out support	Hardwoods	98 mm (3 7/8")

### GUARANTEE

One year guarantee for parts and labour against manufacturing defects. Wear parts and those damaged as a result of non appliance with the instructions of the present manual are excluded from the guarantee.

# PUTTING INTO OPERATION

## 1 ) UNPACKING & REASSEMBLY

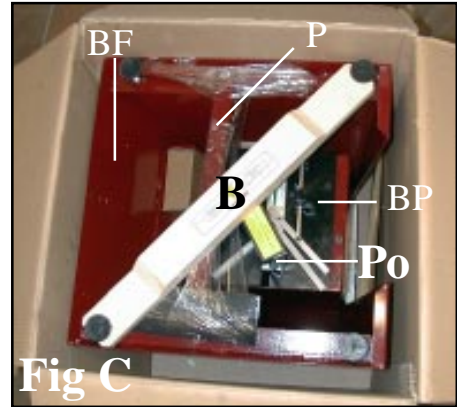
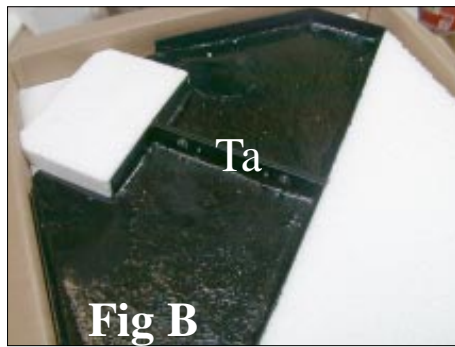
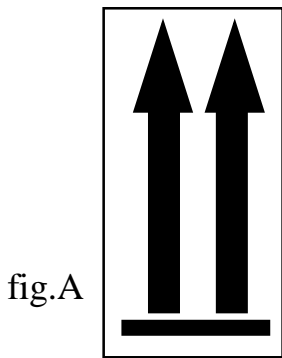

- Keep the package of the machine so, that the arrows drawn on the outside stand up, (see Fig A)
- Open the parcel. Remove machine's table Ta and the foam protection (see Fig. B).
- (See Fig C) Pressing down the crossing wood piece B, loosen and remove one of the two feet of the machine that are holding the wood piece B in place. The wood piece B is pushed up by the machine's top presser; therefore remove it slowly until the machine's top presser is completely free. Fix the removed foot back on machine.
- Remove the foot pedal P and the accessory box now. (See detail of content page 5)
- Remove the turning upper cabinet BP and the bottom cabinet BF. (Fig.C)
- The bottom cabinet BF is upside down; put it right on its feet.
- Place the upper cabinet BP on the bottom cabinet BF.
- Close the locking clips as shown on Fig.D.

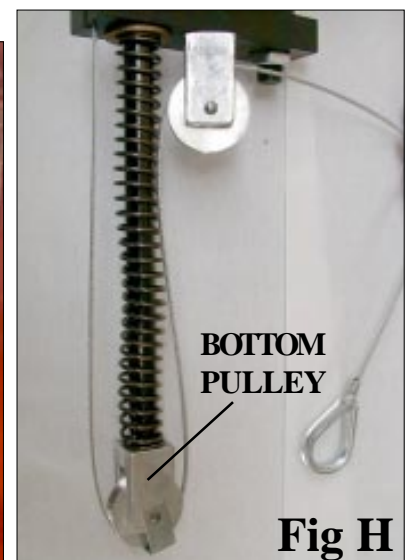
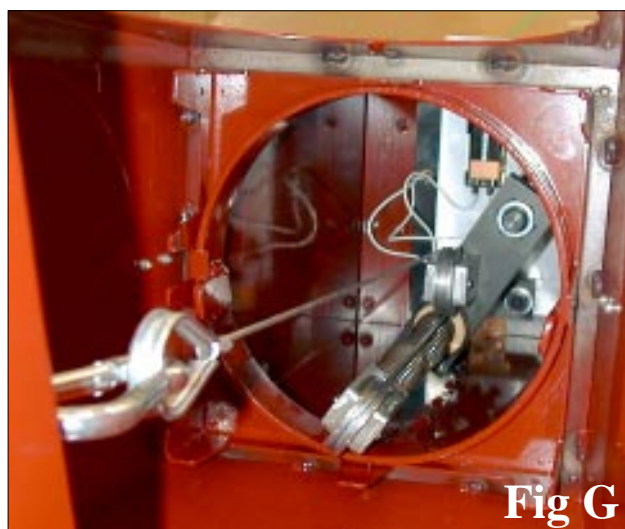
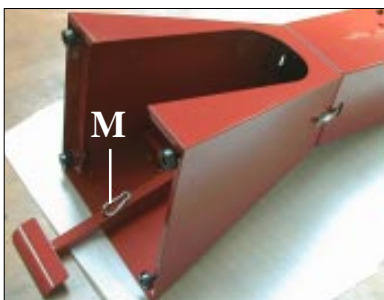
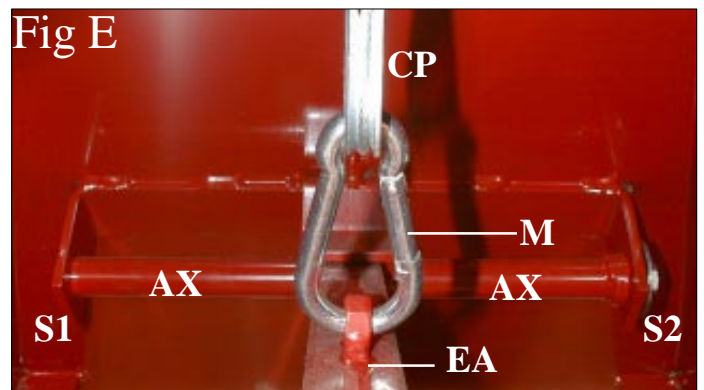
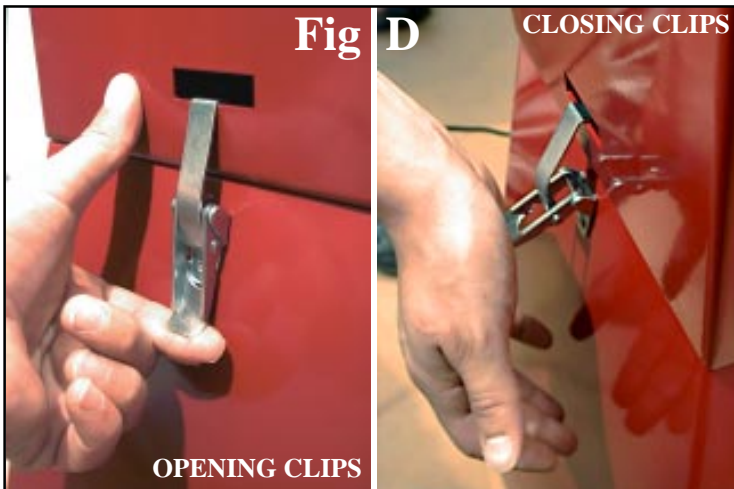



- Lay down the machine gently with the pedal opening on top (see Fig.F).
  - (Fig.F) Assemble the foot pedal; the hook M must be on top. Fix the ends of axle AX on supports S1 & S2 starting with S1 (See Fig.E).
- Then screw to S2 with the 20mm (approx. ¾" long) screw + washer supplied in the accessory box. You need for this a 17mm wrench.
- Check that the cable is engaged on the two pulleys (see Fig.G, H and I)
  - Then engage the cable CP to the hook M (see Fig.E).
  - Try the pedal by hand to make sure that - the cable remains on pulleys and everything is moving smoothly.

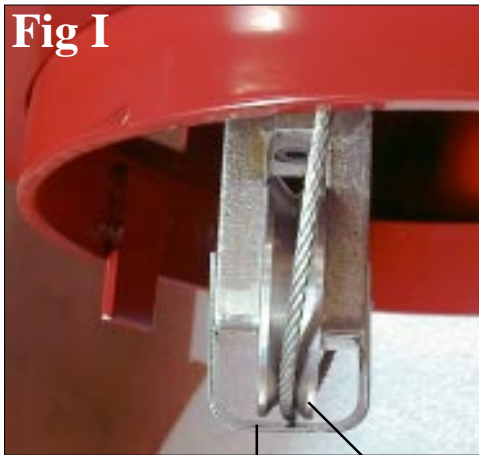

**BOTTOM PULLEY**

**DEVICE HOLDING CABLE IN PLACE**

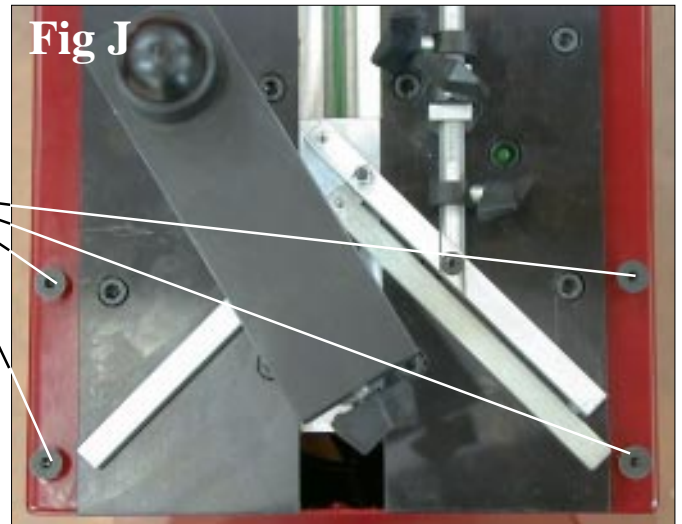

**TABLE  
SCREWS  
VT**

- **Now put the machine CS 79 up on its feet;**
  - **Fix the extension table Ta with the 4 screws VT (see Fig.J).**
  - Adjust the level of the machine with its 4 feet so that it is stable during operation.
- In the accessory box, you will find one nut that is for the foot of the machine which you removed initially and which was therefore without nut. (See Fig K)

**Fig K**

Nut H,M12.  
(19mm wrench needed).



**Foot**

# ADJUSTMENTS

## SELECTION OF STAPLING POSITIONS

The CS 79 is designed to join mouldings in one or two places (positions) without limitation of the number of wedges in any of those places. The selection depends on the width and thickness of the moulding to join.

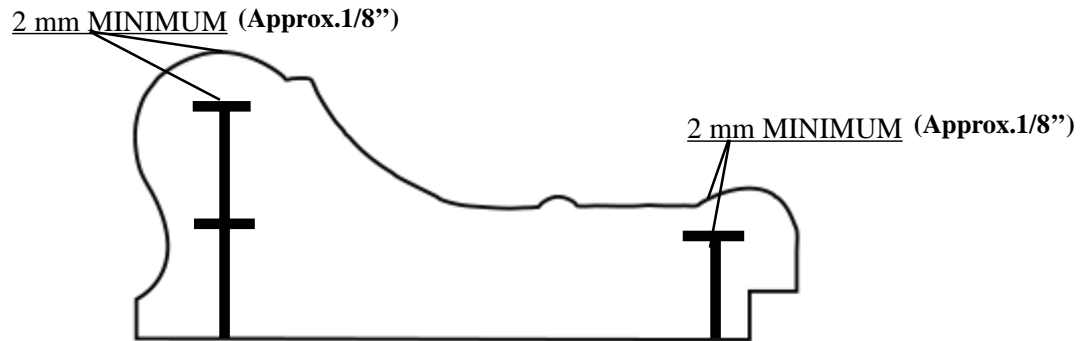

**As a general rule a MINIMUM 2 mm clearance (less than 1/8") above the wedges shall be respected.**

**Same sized wedges can be stacked** in order to avoid to have to change the cartridge size when joining frames with different thickness.

AS A GENERAL RULE, THE JOINING MUST BE CARRIED OUT AS CLOSE TO THE THICKEST MOULDING PART(S) AS POSSIBLE .

## SETTING AND STORING THE STAPLING POSITIONS

Unlock the stapling position lock handles P1, P2 and P3.

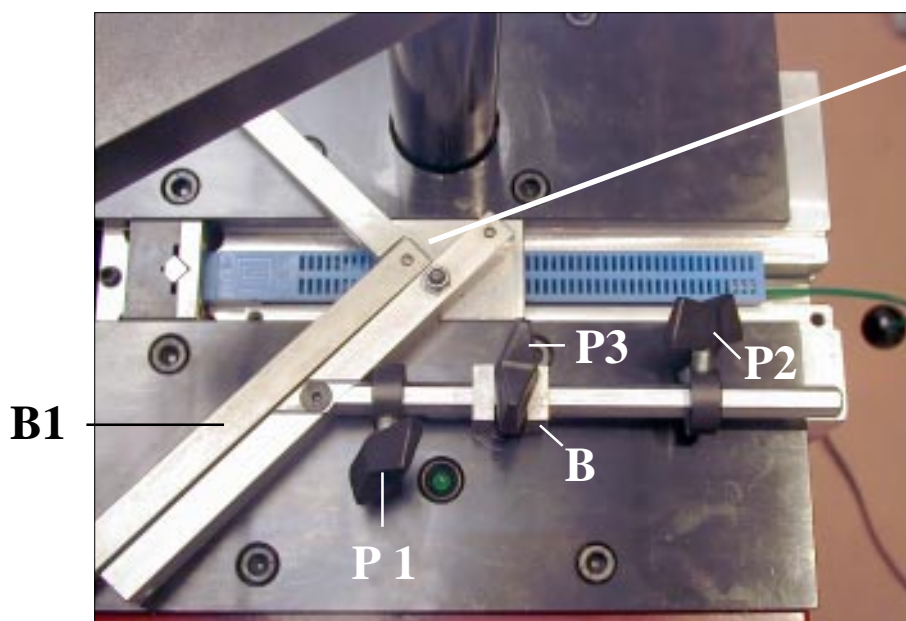

**90° JOINING  
ANGLE ASSEMBLY**

Standing in the work position used of reference for explanations (behind the machine; see Fig 2, page 1), with your left hand, put the first moulding chop in front of the left (1<sup>st</sup>)

backface B1 and bring the chop in contact with the right (2<sup>nd</sup>) backface B2.

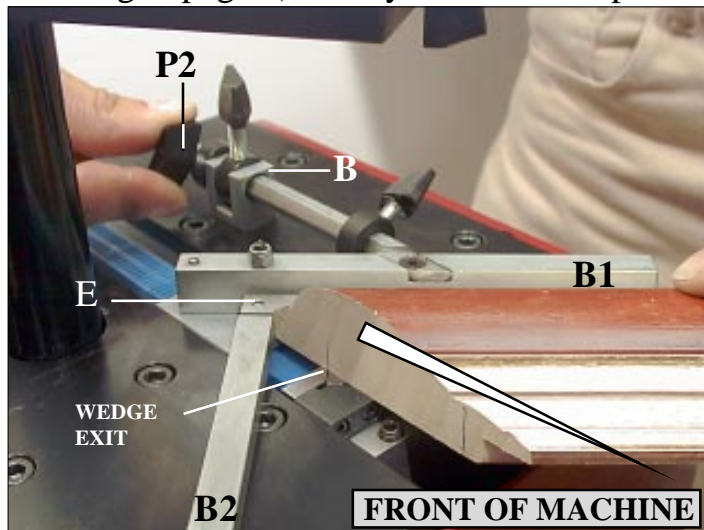

**For the stapling position close to the outside of the frame :**

Move forward the 90° joining angle assembly **E** until the place where you want to insert the wedge(s) has been reached by the **WEDGE EXIT** (see picture). Then bring the lever **P2** against the limit stop **B** and tighten it.

**For the stapling position close to the inside of the frame :**

Move the 90° joining angle backwards, until you have reached the furthest position to the inside of the frame where you want to insert wedge(s). Then bring the lever **P1** against the limit stop **B** and tighten the lever.

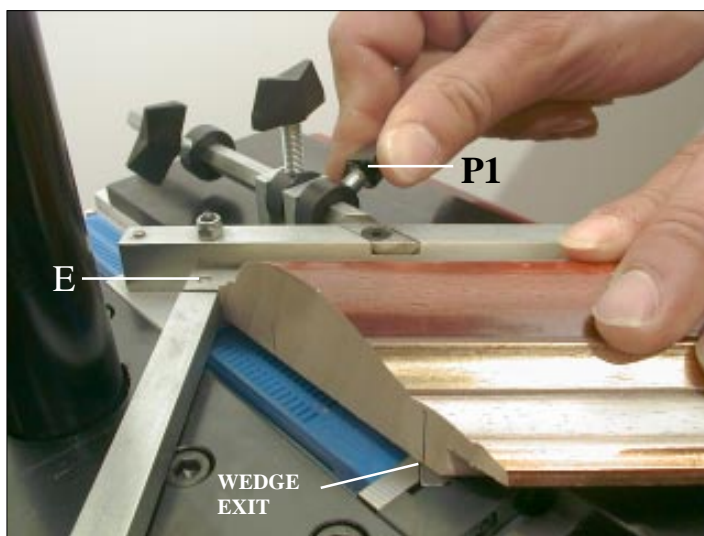

**Now the two positions of joining are set and the machine's 90° angle can move only within the limits of these two positions.**

**In case you would like to insert wedges in between these two positions, or if you are working with a very small moulding and would like to insert wedges only in one place, you can use the lever P3 located on the limit stop B.**

**This intermediate lever P3 also enables you to stack wedges (on top of each other in the same position) without risk of missing the stacking operation (not pushing the first wedge deeper inside).**

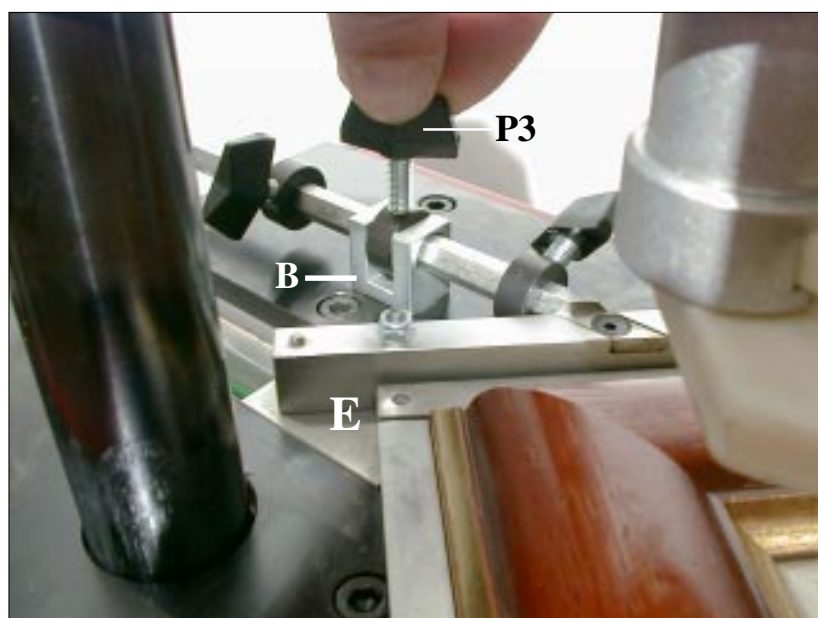



## SELECTION OF A TOP PRESSER END (See page 12 : NEW VERSION TOP PRESSER)

Make sure that the distance between the moulding's top and the presser's bottom is not more than 30 mm (1 1/4"). If the distance is bigger than this, use another (longer) top presser to reduce the distance.

The triangle top pressers with their extra long support that are included with your CS 79 gives you the capacity to work mouldings up to 35 mm (1 3/8") high. For taller mouldings there are other top pressers available from your regular source of Cassese products. See on page 2, the list of other top pressers for your CS 79 and the capacity in height of moulding they would allow you to join.

Triangle top pressers are good for flat mouldings or for mouldings presenting a flat or horizontal area to come down on. The green or orange rubber ends are good for complicated forms (uphill, downhill or reverse mouldings).

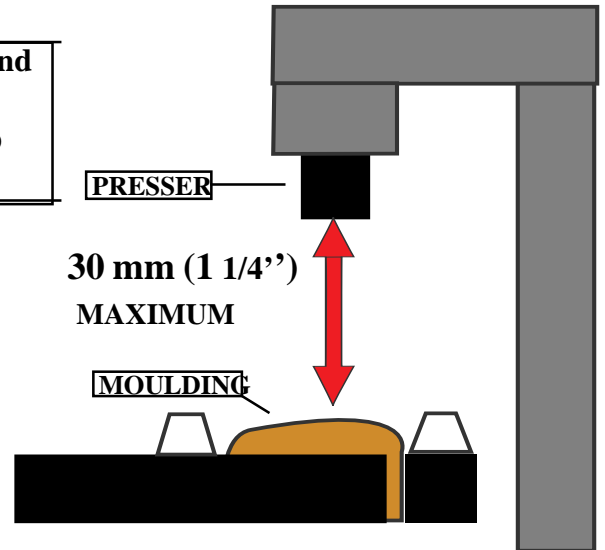

<b>BLACK TRIANGLE PRESSER</b>	<b>HARD WOOD</b>	Fixing in holder with a 2.5 mm Allen key
<b>WHITE TRIANGLE PRESSER</b>	<b>SOFT WOOD</b>	

### ADJUSTMENT OF THE ASSEMBLY ANGLE

If several cutting machines are being used in your production or if you receive your mouldings already cut by your suppliers (chop service), the angles of the mouldings will be slightly different from one cutting machine to the other. The joining angle of your CS 79 can be adapted to find precisely the cutting angle of your cutting machine.

**If the corner is open towards outside, unscrew (turn anti-clockwise) the angle adjustment screw AS (see Fig 1 page 1) a little to correct the fault and check again.**

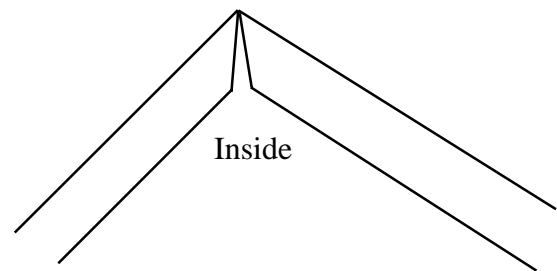
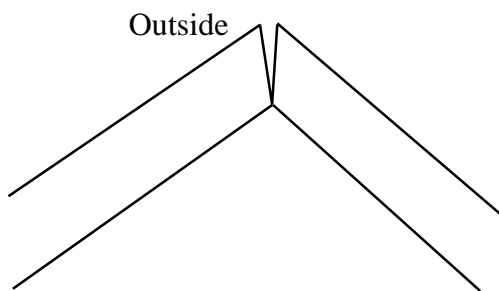

**If the corner is open towards inside, screw in (turn clock-wise) the angle adjustment screw AS (Fig 1 page 1) to correct the fault.**

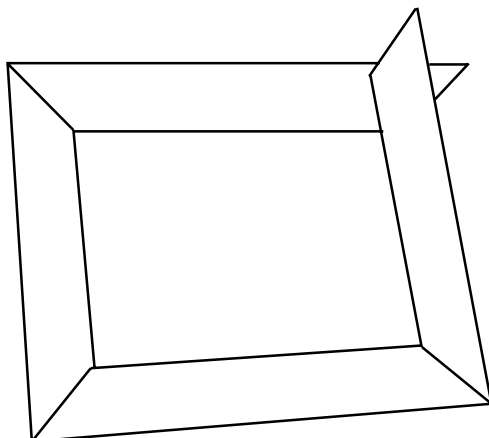

If you get this result, check your cutting angle, which is wrong in this case because it is less than 45°.

Carry out the adjustment of the angle of your cutting machine.

**IT IS IMPOSSIBLE TO MAKE A RECTANGLE FRAME WITH ANGLES SMALLER THAN 90°.**

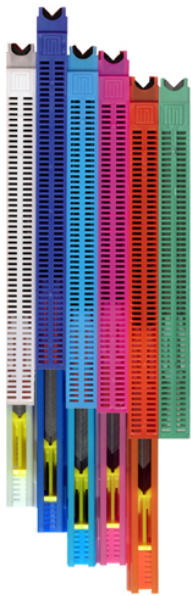

# USE

## MEANS OF ASSEMBLY

The joining is performed by using metal wedges, a Cassese invention, designed to ensure very tight corners. Seven sizes are available : 3, 4, 5, 7, 10, 12 and 15 mm. They come in throw-away cartridges that are colour-coded per size for easy identification. Cartridge wedges exist in two versions : **NORMAL** for soft and normal timbers and **HW** for very hard timbers. These hardwood wedges are to be used only on hardwoods. Your CS 79 machine is designed to use all sizes of Cassese cartridges without having to change any parts on the machine or having to adjust anything.

For the long term performance and reliability of your CS 79, only use genuine CASSESE cartridge wedges. Beware of counterfeit products.

## LOADING AND CHANGING THE WEDGE CARTRIDGE ON MACHINE

Pull the wire with ball of the wedge pusher spring **F** (fig.2, p1) fully out.

If there is a cartridge on machine, holding the wire pulled out, remove it by simply sliding out the cartridge.

Holding the wire pulled out, put a new cartridge on machine and pay attention that it is fully inserted in the wedge distributor's window.

Release gently the wire with ball of the wedge pusher spring **F**.

## JOINING THE FRAME

After selecting and setting the stapling positions (page 5 & 6), adjusting the assembly angle (page 7), checking the distance between the top presser and the moulding (page 7) and loading the best suited type (normal or hardwood) and size of wedges (page 8),

- 1- Put the first (left-hand) moulding in front of the fence B1 and push it so that its mitre end reaches the other fence B2.
- 2- Holding it so, put the second moulding chop against fence B2 and slide it until it reaches the first moulding.
- 3- Holding the mouldings in place against each other, hold the backfences B1 & B2 with your thumbs and make the angle assembly slide backwards until the lever P1 reaches the limit stop B. You can eventually tighten the intermediate lever P3 to be sure that the position remains fixed.
- 4- Still holding the mouldings well profiled against each other, push the foot pedal P (Fig 2, p.1) until the green light V (Fig 1 p1) comes on that indicates that the wedge has been fully inserted. If you intend to stack a second (or third) wedge in the same position, just push the footpedal again until V-light comes on. In this case using (tightening) the lever P3 will enable you to stack them more easily.
- 5- If there is a second stapling position chosen (with lever P2), just repeat the same operation by pushing forward the mouldings and the angle assembly of the machine until P2 reaches the limit stop B. And repeat step 4 above.

# MAINTENANCE

## 1) LUBRICATION

Periodically, remove the wedge distributor (Fig 1, block H) and clean it (by air gun) without dismounting it.

It is recommended to lubricate the hammer (driver blade) periodically. To do so, remove the wedge distributor (block H) and put a small quantity of grease in the bottom hole of the wedge distributor. The hammer will be lubricated every time it crosses the wedge distributor.

## 2) CLEARING OF A WEDGE STUCK IN THE WEDGE DISTRIBUTOR

If you push the foot pedal half way and release, a wedge may be half engaged in the wedge distributor. In this case,

- Try to remove the cartridge that is in position. If it resists, use the wedge removal tool to push down the wedge back in the cartridge.
- Pay attention not to make penetrate the tool more than 6mm (1/4") into the wedge distributor.

**It is important not to leave a wedge half engaged in the wedge distributor, as it may cause the insertion of two wedges when you join the next corner or may cause the jamming of the hammer (the driver blade) in the wedge distributor.**

- In case of the hammer (driver blade) jamming with a wedge in the wedge distributor, see the following section (3).

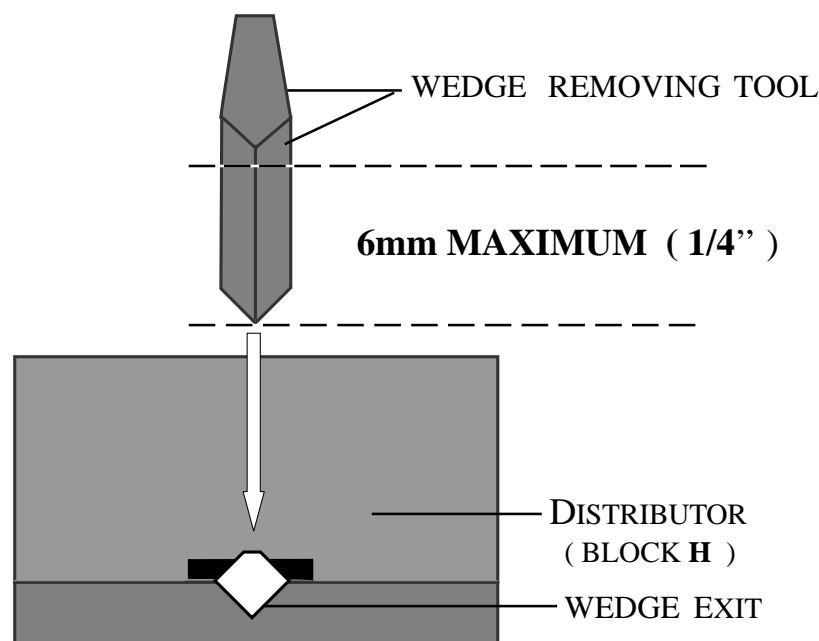

## MAINTENANCE

### 3) IN CASE OF HAMMER AND WEDGE JAMMING

AFTER EACH INCIDENT, IF THE HAMMER STAY JAMMED IN BLOCK H,  
YOU SHOULD HAVE TO CHANGE IT

WEDGE  
DISTRIBUTOR  
(BLOCK H)



LOCKING SCREW

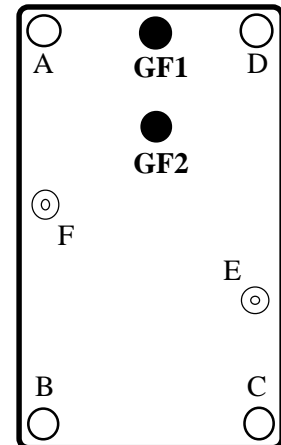

SCREW  
POSITIONS  
BLOCK H

- Remove the cartridge that is on machine, and the top presser.
- Using the 3mm Allen key, loosen the locking screw of the wedge distributor Block **H**.
- Then lift the top presser's bracket arm by hand. The wedge distributor will come out of its housing.
- Remove it from the machine.
- The old hammer (wedge driver blade) is stuck in the wedge distributor : first try to remove it with a pair of pliers. If not possible, remove the four screws (**A, B, C, D**) and open the block **H**. (Two factory set locator pins **E** & **F** allow the plates to be re-positioned precisely again.)
- Remove the old hammer. Assemble the Block **H** back again.

#### **Putting a new hammer (driver blade) :**

- Put a drop of grease in the bottom hole of the wedge distributor (block H).
  - Insert a new hammer into block H with the hole of the hammer downwards.
  - Re-position the wedge distributor in its housing on the machine with the window towards the cartridge.
  - If the upper end of the hammer stays out of the block H, push it fully in with a piece of wood or moulding.
- While keeping the moulding in place (on block H) and pressing on it, pull up the top presser's bracket arm Po (Fig1 p1) with a quick movement.
- The new hammer must have taken its position in the mechanism automatically.
- Check with your finger that the block **H** does not stay out of the machine (higher than the work level) and tighten the locking screw of block **H**. No need to tighten too much.
  - The machine is ready to work again.

**If you have any difficulty to remove the block H from the machine, push down with your hands the top presser's bracket arm.  
This should free the block H that is stuck with the hammer.**



## **REPLACEMENT OF BATTERY** **OF WEDGE-FULLY-INSERTED INDICATOR**

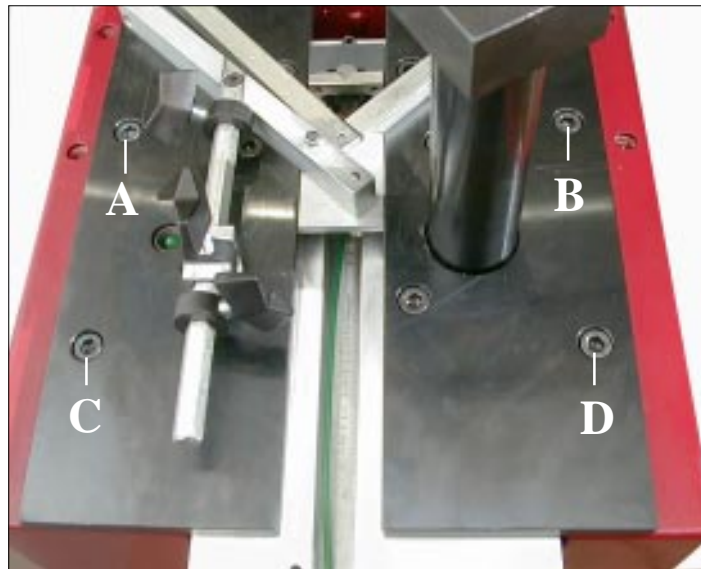

**Remove the cable of the foot pedal from hook M (Fig. F, page 3).  
With a 5mm Allen key (supplied in the accessory box), undo and remove the 4 screws A-B-C-D that fix the mechanism of the machine to the upper cabinet. See picture above.**



**Battery 9 V**

**Now, you can remove the mechanism out of the cabinet and access to the battery that is a standard 9 V one. See picture above. Please replace the empty battery.**

**Cassese CS 79 FOOT OPERATED UNDERPINNER**  
NEW VERSION TOP PRESSER (item # Z6232)



**This new version top presser comes now with your CS 79 as a standard feature. Its height can be adjusted with the pin so that the machine can work up to 78 mm (3''1/8) tall mouldings. Pay attention to keep always maximum 30mm (1''1/4) distance between the top presser and the mouldings and to keep the rubber triangle parallel to the 90° angle assembly (backfences B1 & B2, Fig.1, p. 1)**



**The moulding height capacity of the new triangle top presser support for its 4 positions :**

- 1) 37 mm (1''1/2)
- 2) 53 mm (2''1/8)
- 3) 68 mm (2''3/4)
- 4) 78 mm (3''1/8)

**OPTIONAL ACCESSORY (Cassese item # Z.6233)**

A similar adjustable support for the round rubber top pressers is now available with 3 positions for its height.

As the round rubbers are available in two lengths (30mm & 45mm) and in two hardness finishes (orange for softwoods & green for very hardwoods), the maximum height of moulding that this optional round rubber support can work in its three positions are :

<b>Position hole #</b>	<b>With short round rubber</b>	<b>With long round rubber</b>
<b>1</b>	<b>37 mm (1''1/2)</b>	<b>22 mm (7/8'')</b>
<b>2</b>	<b>53 mm (2''1/8)</b>	<b>37 mm (1''1/2)</b>
<b>3</b>	<b>68 mm (2''3/4)</b>	<b>53 mm (2''1/8)</b>

**IMPORTANT :**

**In any position of the top presser, to insert wedges fully in, the distance between the moulding and the down end of the top presser shall not exceed 30 mm (1''1/4). If so, change the position of the top presser and bring it closer to mouldings.**