



*Quality for the world*

# CS 4095 Ultra





## Technical and User Manual

V4 02/2002

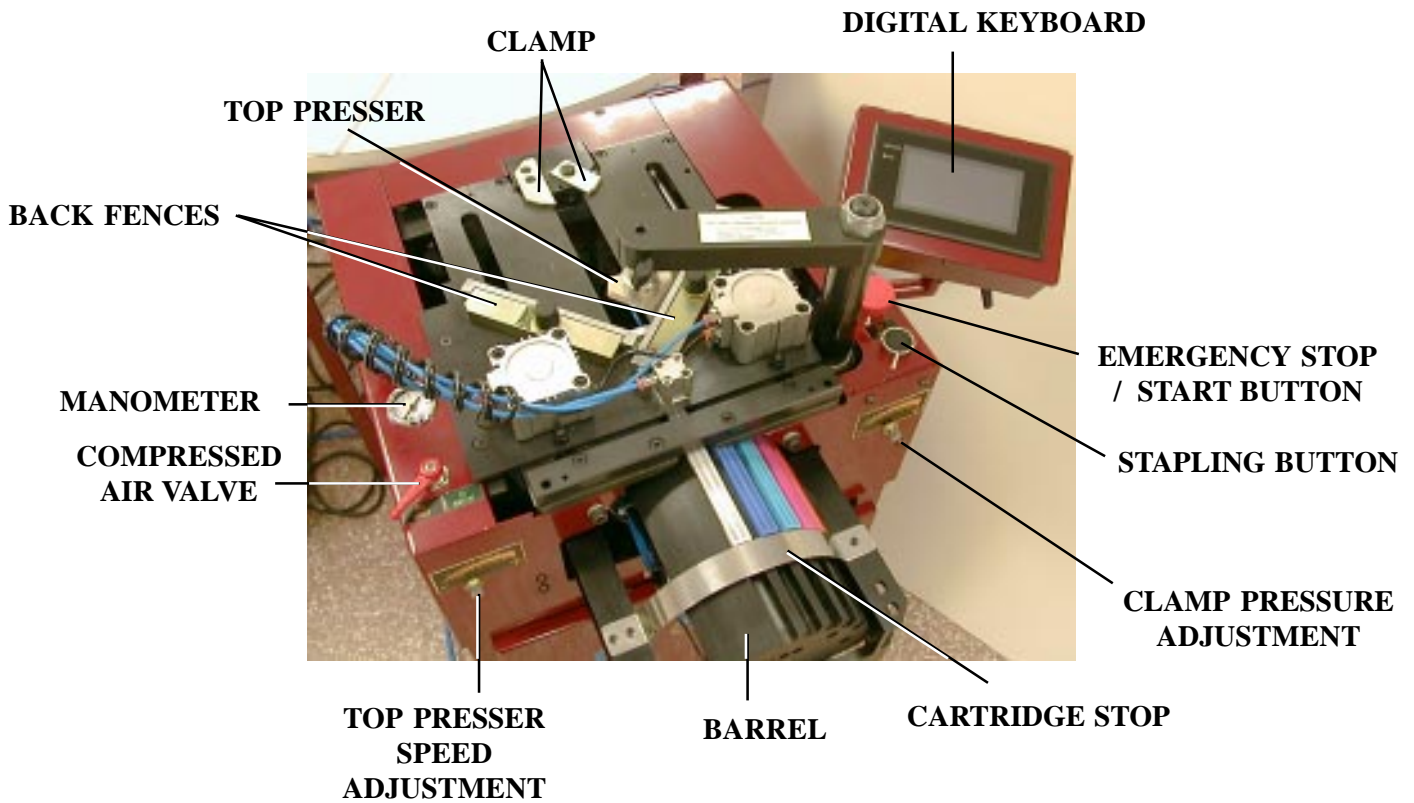
# CS 4095 Ultra



## TOUCH - SCREEN SYMBOLIC BUTTONS

	SELECTION OF VALUE BY REPEATED PUSHES .
	RECORD OF A NUMERIC VALUE
<b>ENTER</b>	RECORD OF ALL VALUES ON A SCREEN .
<b>CLR</b>	TO CLEAR A VALUE .
<b>RETURN</b>	TO COME TO PRECEDENT VALUE .
<b>NEXT</b>	TO GO TO NEXT MENU .
	HELP ( EXPLANATIONS )

### MANUAL MODE

Your CS4095 can work on 3 different manual modes:

**MINIMUM** (manual) : the foot pedal pushed, the complete joining cycle is carried out by pushing the stapling button once.

**MEDIUM** : the foot pedal pushed, the wedges of one stapling position are inserted when the stapling button is pushed once.

**MAXIMUM** (manual) : the cycle is fully detailed: the stapling button inserts only one wedge at a time.

# IMPORTANT

## FUNCTION PARAMETERS

On MAIN MENU, enter **MAINTENANCE** / Then enter **NEXT** on INPUTS screen / **NEXT** again / CAUTION message **NEXT** / you get to the machine's function

### PARAMETERS screen

LANGUAGE :	FRANÇAIS	1	2	3
MANUAL MODE :	MINIMUM	4	5	6
TABLE OFFSET :	0000	7	8	9
WEDGES OFFSET :	0000	0	CLR	↩
PINCODE :	0000			
		↓	RETURN	NEXT

### LANGUAGE

You can change the active language ...by pushing on **LANGUAGE**

### MANUAL MODE

See detailed explanation on previous page A

### PARAMETERS

On the PARAMETERS screen, pushing key **↓** each parameter can be modified.

**TABLE OFFSET** and **WEDGE OFFSET** ARE FACTORY SET , DO NOT MODIFY THEM , UNLESS REQUESTED BY YOUR CASSESE SUPPLIER .

### PINCODE

Your CS4095 is equipped with two codes which prevent the operator to access to certain Menus:

(1) **CODE 2802** disactivates both access to **JOINING FILE** and to **EXECUTE DIRECTLY** so no article can be cancelled, modified or added to the memory.  
Nor can be joined any moulding which is not in file.

(2) **CODE 2803** blocks the access to **EXECUTE DIRECTLY** menu, so that no moulding which is not in file can be assembled on the machine or no moulding in file can be joined with modifications of its joining paramaters.

To cancel PINCODE menu limitations, enter the Pincode once again, then **↩**  
**RETURN** brings you back to MAIN MENU.

# INTRODUCTION SCREEN

## MAIN MENU

### JOINING FILE

CREATE

MODIFY

ERASE

LIST OF ARTICLES

### CARTRIDGE FILE

### MAINTENANCE

INPUTS

OUTPUTS

PARAMETERS

HAMMER  
CHANGE

LANGUAGE

MANUEL MODE

PINCODE

TABLE OFFSET

WEDGE OFFSET

### EXECUTE

EXECUTE FILE

EXECUTE DIRECTLY

MOULDING PARAMETERS

FINE TUNE

AUTO/MANUAL

WITH /OUT SPACERS

SEE BARREL

45°  
30°  
22.5°

WEDGE PUSHER

**PROGRAMME OF  
CS 4095  
VERSION 3**

# CS 4095 ULTRA AIR LINE FITTINGS

Advised way of fitting :



Z 675

USA

STANDARD

Male Connector  
on Machine



Z 675



quick release (Q/R)  
female air connector

Z 749



Q/R US male  
connector

Z 701

Standard hose  
connector

Z 556



AIR SOURCE (compressor)



# CASSESE CARTRIDGE WEDGES

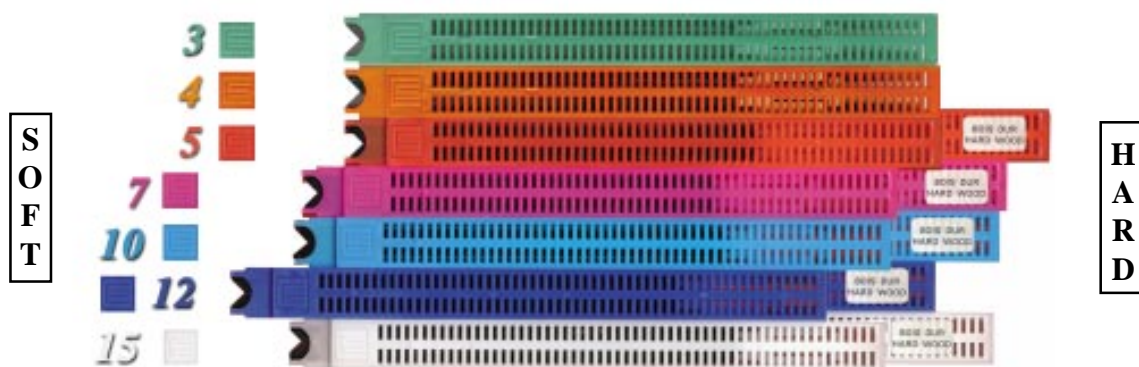

*The joining is performed by using metal wedges, a Cassese invention, designed to ensure very tight corners.*

*Five standard sizes are available : 5, 7, 10, 12 and 15 mm.*

*On special request #3 & 4 are available for slips (filets).*

*They all come in throw-away cartridges that are colour-coded per size for easy identification.*

## Cartridge wedges exist in two versions :













**NORMAL** for soft and normal timbers and













**HW** for very hard timbers. *These hardwood wedges are to be used only on hardwoods.*

*Your CS 299M Ultra is designed to use all sizes of Cassese cartridges without having to change any parts on the machine or having to adjust anything.*

*For the long term performance and reliability of your CS 299M Ultra, only use genuine CASSESE wedge cartridges.*

*Beware of bad quality copies that would cause technical problems and would age your machine prematurely.*

REFERENCE	TYPE
	-----
	-----
	30305NCOI 5 mm
	31305BDCO 5 mmBD
	30307NCOI 7 mm
	31307BDCO 7 mmBD
	30310NCOI 10 mm
	31310BDCO 10 mmBD
	30312NCOI 12 mm
	31312BDCO 12 mmBD
	30315NCOI 15 mm
	31315BDCO 15 mmBD

REFERENCE	TYPE
	30403NCOI 3 mm
	30404NCOI 4 mm
	304 05 NCOI 5 mm
	314 05 BDCO 5 mm BD
	304 07 NCOI 7 mm
	314 07 BDCO 7 mm BD
	304 10 NCOI 10 mm
	314 10 BDCO 10 mmBD
	304 12 NCOI 12 mm
	314 12 BDCO 12 mmBD
	304 15 NCOI 15 mm
	314 15 BDCO1 15 mmBD

Boxes of 6 cartridges (app. 275 wedges)  
**(1650 wedges / box)**

Boxes of 40 cartridges (app. 275 wedges)  
**(11000 wedges / box)**

# Contents

PAGES

## **IMPORTANT**

- DESCRIPTION - TOUCH SCREEN - MANUAL MODE A
- FUNCTION PARAMETERS B
- PROGRAMME OF CS 4095 VERSION 3 C
- CS 4095 ULTRA AIR LINE FITTINGS D

## **INTRODUCTION**

- ACCESSORIES
- SPECIFICATIONS 1
- OPTIONS
- GUARANTEE

## **INSTALLATION**

- ASSEMBLY OF THE KEYBOARD
- CONNECTIONS | PNEUMATIC  
ELECTRIC 2

## **HOW TO USE**

THE MEANS OF ASSEMBLY  
SELECTION OF THE STAPLING POSITION 3

START UP & LOADING THE BARREL 4

PREPARATION FOR PRESET RECORDING ----- 5  
RECORDING OF AN ARTICLE 5 - 6  
CHOICE OF A TOP PRESSER - USE OF THE SET OF SPACER - BARS ----- 7 - 8  
SETTINGS : INCLINATION OF THE FENCES , ANGLE OF ASSEMBLY 8 - 9  
EXECUTION OF AN ARTICLE ----- 9 - 10  
EXAMPLE AND ENTRY OF AN ARTICLE WITH 3 STAPLING POINTS 11-12

MODIFICATION & CANCELLATION OF AN ARTICLE 13  
PRESET FOR VOLUME PRODUCTION 14

SCREEN MESSAGES - FAULTS AND REMEDIES 15

MAINTENANCE 16-18  
SPARE PARTS - DRAWINGS 19

## ACCESSORIES

The CS 4095 is delivered with the following accessories:

- 1 trapdoor key.
- 1 quick release female air connector for the male one that is on machine
- 1 quick release US male connector / 1 hose connector
- 1 triangle support with:
  - 1 Black triangle (for hard woods).
  - 1 White triangle (for normal wood).
- 1 rubber support with, depending on the form of the mouldings:
  - 1 Green rubber stop (for 30 & 45 mm hard woods).
  - 2 Yellow rubber stops (for 45 & 30 mm normal wood).
- 1 Spacer bars for small mouldings.
- 1 x 2.5 mm Allen key.
- 1 x 3 mm Allen key.
- 1 x 5 mm Allen key .
- 1 wedge removing tool.
- 1 spare hammer.
- 1 tube of grease.

See page D

## SPECIFICATIONS

Minimum width of the moulding	:	3 mm
Maximum width of the moulding	:	130 mm
Minimum frame dimensions	:	85 x 85 mm
Size of the Cassese wedges in cartridges of 275	:	5, 7, 10, 12 and 15 mm.
Two types of staples	:	normal wood and hard wood.
Weight of the CS 4095	:	120 kg.
Dimensions	:	Width without desk = 45 cm, Depth = 50 cm, Height = 114 cm
Power supply	- electric	: 220 V or 110 V single phase.
	- pneumatic:	compressed air at 6 - 7 bars, consumption 5 litres per cycle.
Air preparation	:	pressure reducer + manometer, connection by tube of 8
mm		internal diameter.

## OPTIONS

- Rotating extension table .
- 6 sided frame attachments
- Special clamps for furniture mouldings
- 8 sided frame attachments

## GUARANTEE

The CS 4095 is guaranteed for one year, spare parts and labour, against all manufacturing faults. Wearing parts and those damaged by use which is not in accordance with that laid down by this document are excluded from the guarantee.



# INSTALLATION

For safety during transportation, your CS 4095's sliding table ST has been blocked with a screw S.

This screw is just behind the angle adjustment button AA. It is very important that you remove the screw S with allen key N° 5 provided with the machine, and fix it back in case of further transportation of your CS 4095.

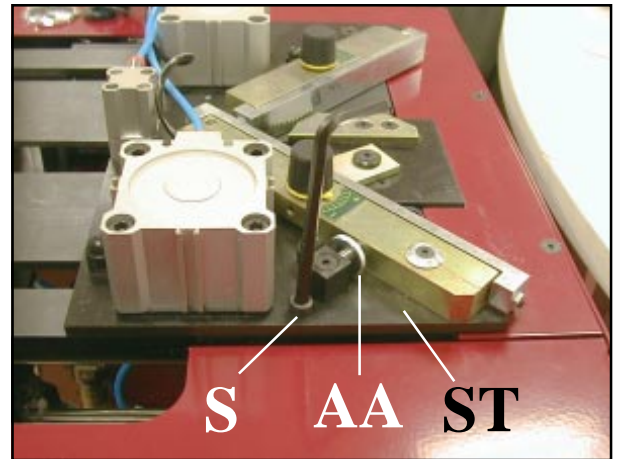

## 1 Assembly of the digital keyboard

Fit the keyboard support S into the sleeve A, then tighten the sleeve from the inside with a flat 30 mm spanner (not supplied). Put the keyboard in the support and position it to suit your work position, then tighten the handles M & N.

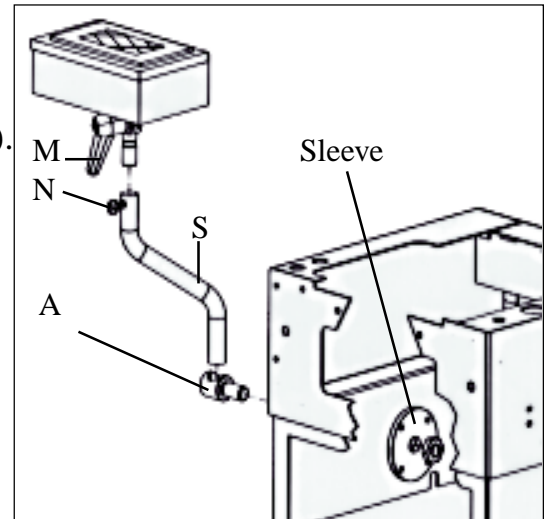

## 2 Pneumatic connection

After opening the access trap with the trapdoor key, the compressor output is connected to the pressure regulator PR of the CS 4095 with a quick fit connection, which is also supplied.

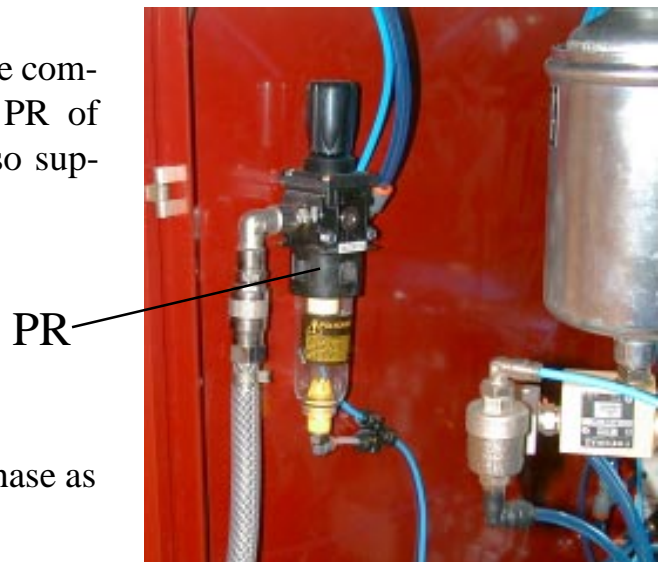

## 3 Electrical connection

Connect the CS 4095 to a 220 volt or 110 volt single phase as appropriate grounded electrical socket.

## THE MEANS OF ASSEMBLY

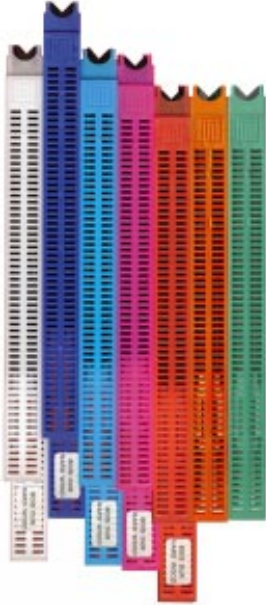

The joining is performed by using metal wedges, a Cassese invention, designed to ensure very tight corners. Five standard sizes are available : 5, 7, 10, 12 and 15 mm. On special request #3 & 4 are available for slips (filets). They all come in throw-away cartridges that are colour-coded per size for easy identification.

Cartridge wedges exist in two versions : NORMAL for soft and normal timbers and HW for very hard timbers. These hardwood wedges are to be used only on hardwoods. Your CS 4095 Ultra is designed to use all sizes of Cassese cartridges without having to change any parts on the machine or having to adjust anything. For the long term performance and reliability of your CS 4095 Ultra, only use genuine CASSESE wedge cartridges. Beware of bad quality copies that would cause technical problems and would age your machine prematurely.

## SELECTION OF THE STAPLING POSITION

The CS 4095 is designed to carry out the joining of mouldings at 1 to 3 places with 1 to 9 staples at each of these positions. The stapling positions and the size of wedges to use are decided by the height of the mouldings to be assembled.

Wedges of the same size may be stacked on each other.

In general, allowance is made for a **MINIMUM** margin of 2 mm above the wedges.

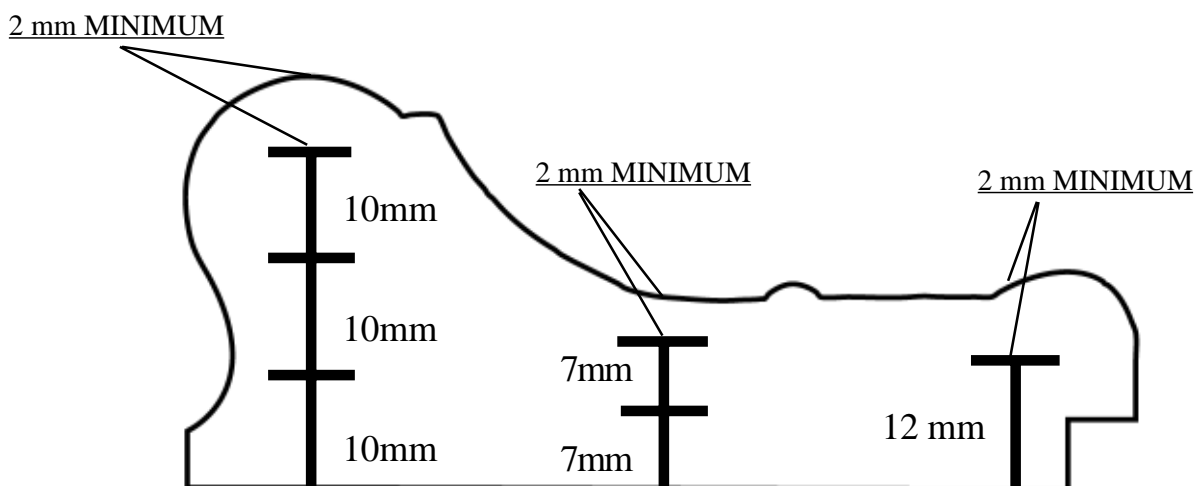

In all cases stapling should be carried out as close as possible to the highest parts of the moulding.

## START UP

Switch the compressed air valve ON. The manometer should indicate a pressure between 6 and 7 bars.

Turn the red start button and

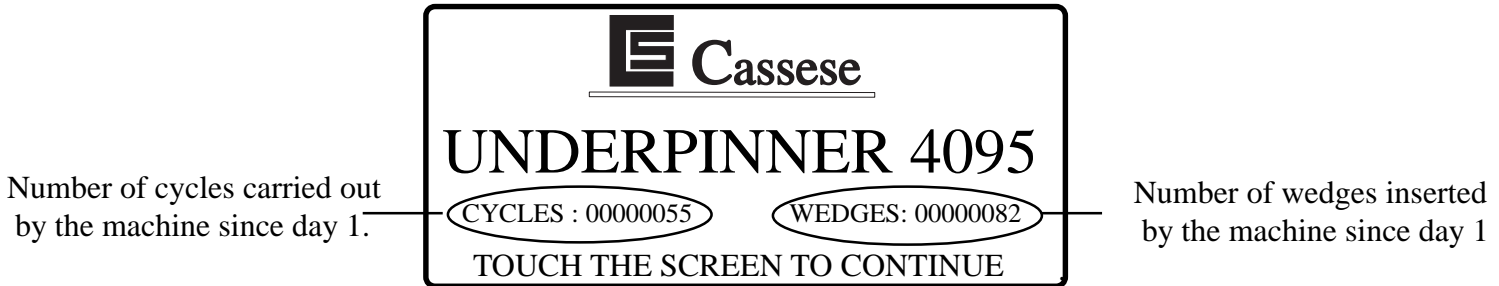

Touch the screen to get to the MAIN MENU.

## LOADING THE BARREL

On the MAIN MENU , enter **CARTRIDGE FILE**

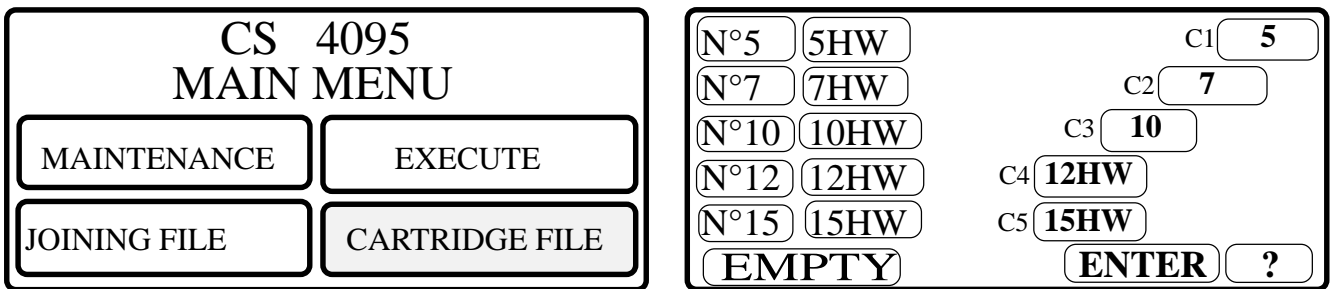

As soon as you enter **CARTRIDGE FILE** on MAIN MENU , the machine brings out its barrel and presents the channel # 5 . Each channel can receive all sizes of cartridges both for normal and hardwoods (HW).

Lift up the CARTRIDGE STOP and insert the cartridge you have selected under it in channel # 5. Then enter on the screen the type of cartridge you have inserted. The CS4095 will check if the cartridge contains wedges.

Select another channel on the digital screen. The machine will present the new channel selected. Proceed in the same way as for the previous channel; insert a cartridge and inform the machine on the type of cartridge inserted.

You can declare a channel EMPTY even if you put a cartridge in this channel. In this case, the CS4095 will not use the cartridge in this channel. All channels in which there will be no wedge left during work will be declared automatically EMPTY by the CS4095. A channel physically EMPTY or with a cartridge not containing any wedge cannot be declared as having wedges in.

After having loaded the barrel with Cassese cartridges, push the key **ENTER** on the keyboard screen. The CS4095 will return to the initial position (MAIN MENU).

# ASSEMBLY

## 1) PREPARATION FOR PRESET RECORDING

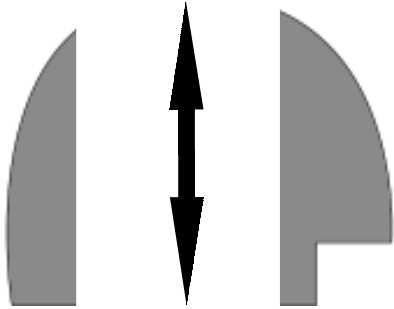

The highest portion of this moulding gives the best position for stapling.

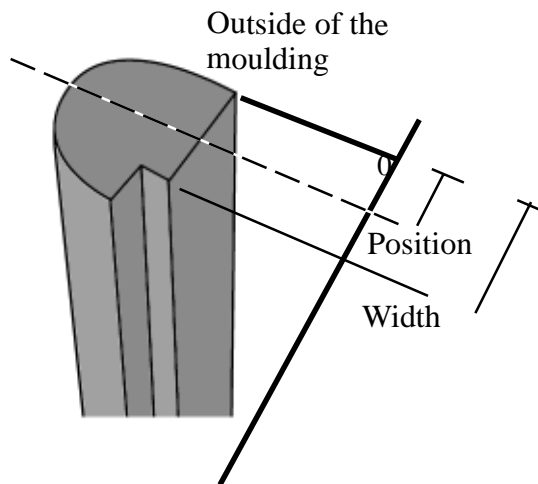

The width of the moulding, excluding the rebate, and the position of the wedge are measured in millimetres, perpendicularly to and starting from the outside edge of the moulding.

The moulding has a reference number of 8 digits maximum.

## 2) RECORDING OF AN ARTICLE

To create an article\* containing all the assembly data for a type of moulding, go to the main menu and press the **JOINING FILE** key followed by the **CREATE** key.

CS 4095 MAIN MENU	
MAINTENANCE	EXECUTE
JOINING FILE	CARTRIDGE FILE

<b>GESTION DES ARTICLES</b>	
<b>CREATE</b>	
<b>MODIFY</b>	
<b>ERASE</b>	<b>?</b>
	<b>RETURN</b>

\*1000 articles maximum .

**Every numeric information should be confirmed with the  key. Otherwise the keyboard will keep the previous information.**

REFERENCE TO CREATE  
00000124

1 2 3  
4 5 6  
7 8 9  
0 CLR 

RETURN ?

- Enter the reference number of the moulding. In case of mistake, press **CLR** and start again. Confirm with key 
- Page 1 of the Joining Parameters comes up.

REFERENCE 00000124

MOULDING WITH : 011

WHITE TRIANGLE  
SPACER

1 2 3  
4 5 6  
7 8 9  
0 CLR   
↓

PAGE 2 ENTER RETURN ?

- Enter the moulding's width in mm, confirm with key 
- By pushing several times on the key presenting the top pressor types proposed by the machine, leave it on the top pressor type you want. Pushing on key **SPACER** (you will darken this key), and the CS4095 will ask automatically for the spacer bars for this moulding. Pushing **PAGE 2** key, you access to the second and last page of joining data.

MOULDING WIDTH 011

POSITION	1	2	3
SIZE	005	000	000
NOMBRE	5	5	5
	0	0	0

1 2 3  
4 5 6  
7 8 9  
0 CLR   
↓

PAGE1 ENTER RETURN ?

- On the numeric screen, enter the distances of the joining positions from the back of moulding in mm , from the closest position (Pos 1) (smallest value) to the furthest position (biggest value). Confirm with 
- To select the wedge sizes to be inserted, enter **SIZE** key . A new screen will appear:

POSITION 1	POSITION 2	POSITION 3
7	5	5

WEDGE SELECTION

5 7 10 12 15

5HW 7HW 10HW 12HW 15HW

SEE BARREL ENTER ?



- Enter the position selected (key darkens) and enter the size decided for this position. You can also check the sizes available in the barrel. After having entered the sizes for the positions, push **ENTER** key to come back to the previous screen of joininy data. If you wanted only 2 positions, the 3<sup>RD</sup> position will still keep a wedge size, but the machine will not take it into account if there is no value for 3<sup>RD</sup> stapling position).

Moulding Width 011

POSITION	1	2	3
SIZE	005	00	00
NUMBER	7	5	5
	1	0	0

1 2 3  
4 5 6  
7 8 9  
0 CLR   
↓

PAGE1 ENTER RETURN ?

With the  key , bring the selection rectangle to the wedge number and enter the quantity of wedges you want in this position . Confirm the number with . Once you enter all position values and wedge numbers , push **ENTER** key. **RETURN** Cancels the recording and brings you back to FILES MANAGER menu .

### 3) THE CHOICE OF A TOP PRESSER

Check that the run between the top of the moulding and the bottom of the presser is not more than **50 mm ( 2" )**

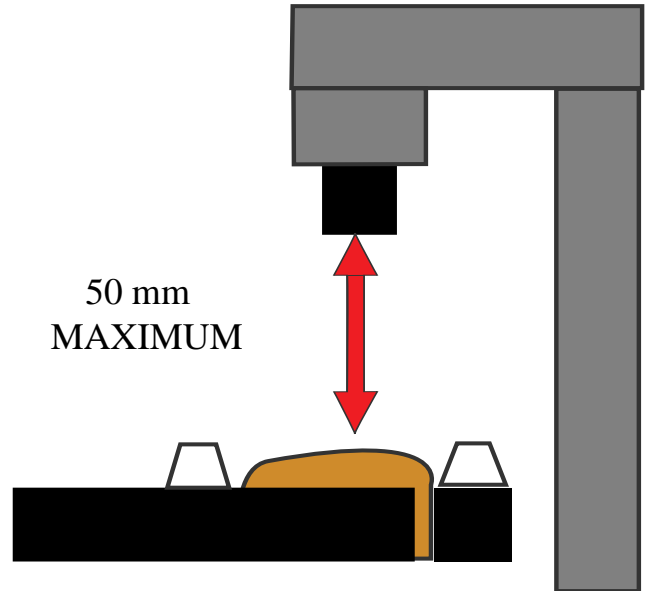

<b>BLACK TRIANGLE PRESSER</b>	<b>HARD WOOD</b>	Fixing in holder with a 2.5 mm Allen key
<b>WHITE TRIANGLE PRESSER</b>	<b>SOFT WOOD</b>	
<b>GREEN RUBBER TIPS</b>	<b>HARD WOOD</b>	<b>30 and 45 mm</b>
<b>YELLOW RUBBER TIPS</b>	<b>SOFT WOOD</b>	<b>30 and 45 mm</b>

### 4) THE USE OF THE SET OF SPACER BARS

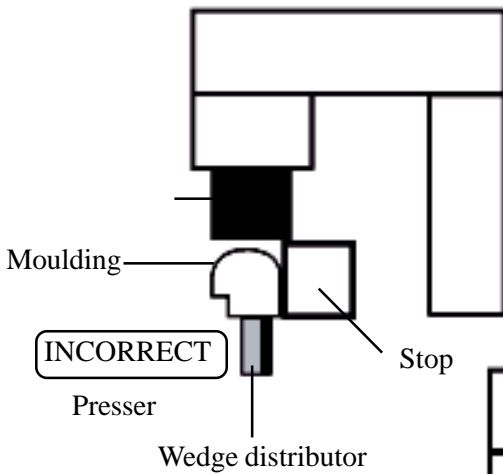

If small mouldings are being assembled which are of a smaller height than the fences, the use of the set of spacer bars supplied is essential.

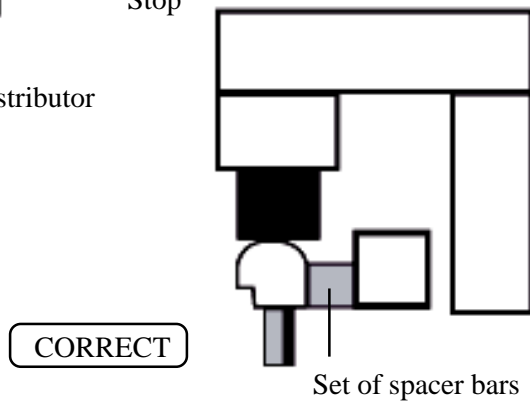

# ADJUSTMENT OF THE INCLINATION OF THE FENCES

ADJUSTMENT BUTTON FOR THE  
INCLINATION OF THE FENCES

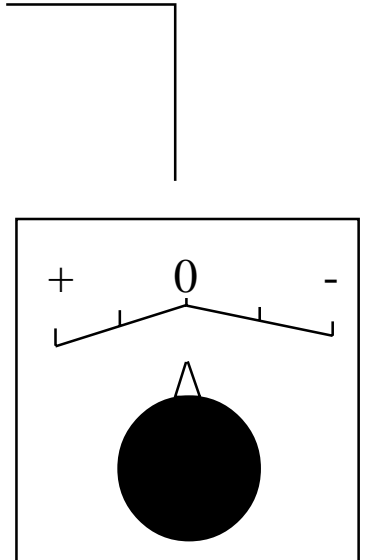
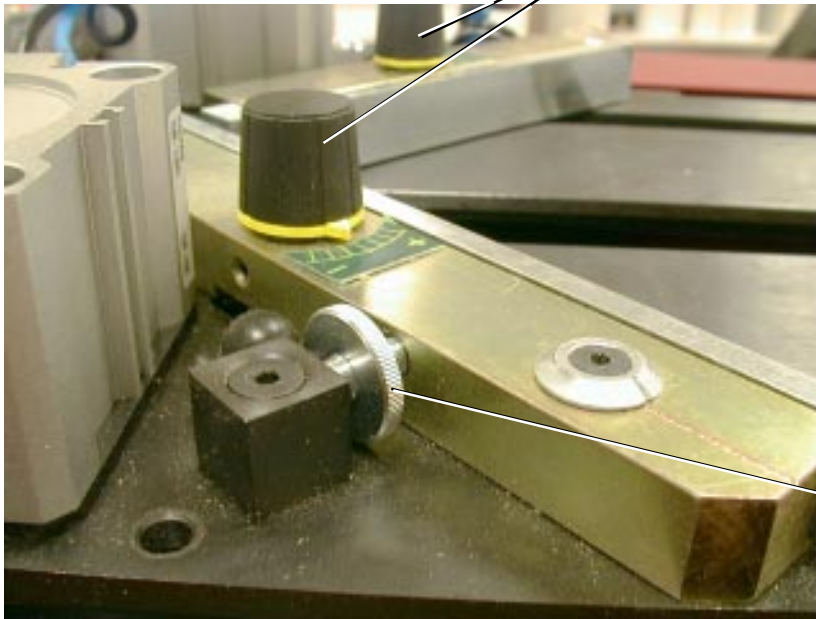

SETTING SCREW FOR  
THE ASSEMBLY ANGLE

If the assembly has an opening **on top**, turn the 2 adjustment buttons for the inclination of the fences towards the MINUS (-) by an identical amount.

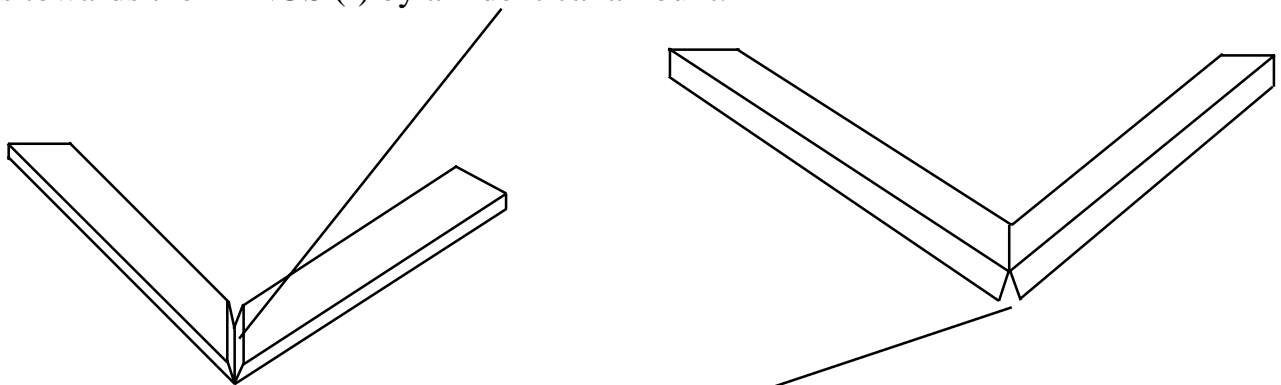

If the assembly has an opening **underneath**, turn the 2 adjustment buttons for the inclination of the fences towards the PLUS (+) by an identical amount.

# ADJUSTMENT OF THE ANGLE OF ASSEMBLY

If the angle is open on the **outside**, **Screw in** the setting screw (see photo page 8) to correct the fault and check the adjustment by tightening the mouldings against the fences.

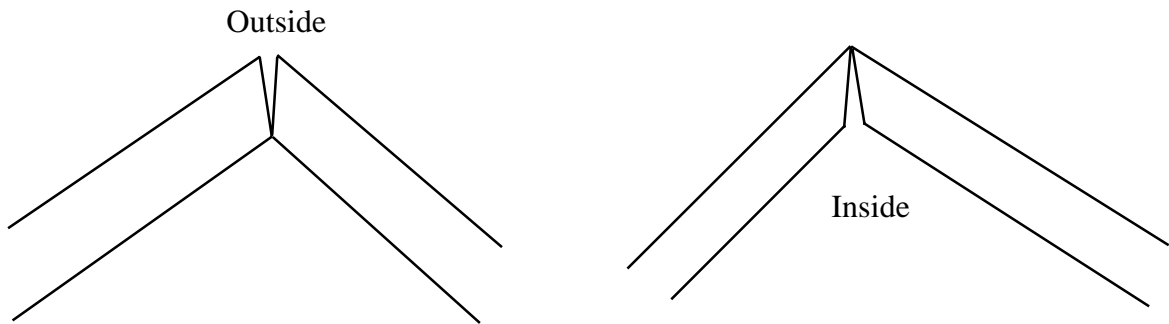

If the angle is open on the **inside**, **Unscrew** the setting screw (see photo page 8) to correct the fault and check the adjustment by tightening the mouldings against the fences.

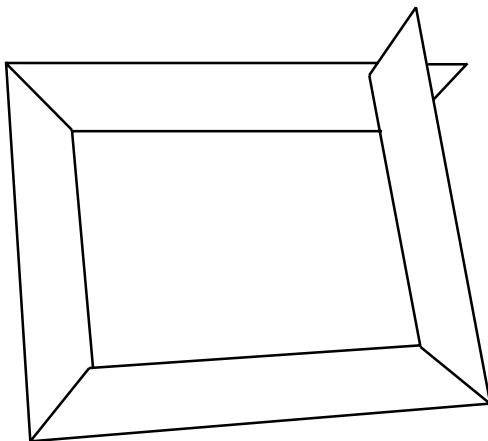

If you get this result, check your cutting angle, which is wrong in this case because it is less than 45°. Carry out the adjustment of the angle of your cutting machine.

**IT IS IMPOSSIBLE TO MAKE A RECTANGLE FRAME WITH ANGLES SMALLER THAN 90°.**

## 5) EXECUTION OF AN ARTICLE

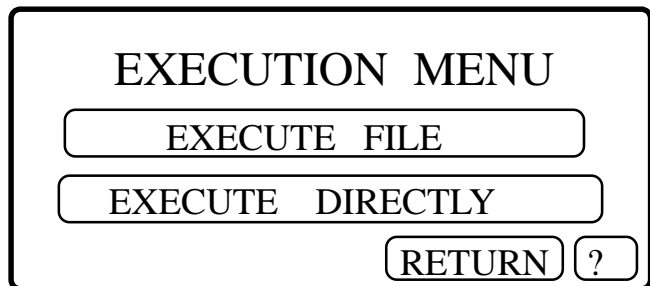
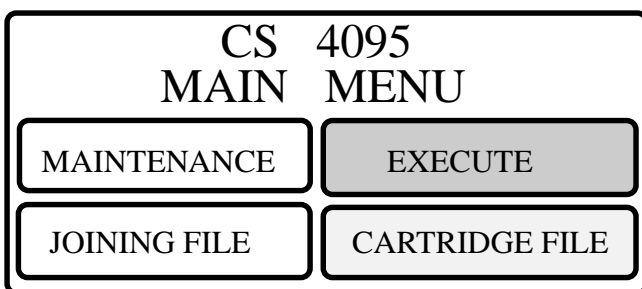

On the MAIN MENU , press **EXECUTE** .In EXECUTION MENU , there are 2 possibilities :

1 ) **EXECUTE FILE** to execute a moulding which is in the memory of the machine . In this case , enter the moulding number , confirm with **↵** key .

In case of mistake , press **CLR** **RETURN** key brings you back to the previous menu .

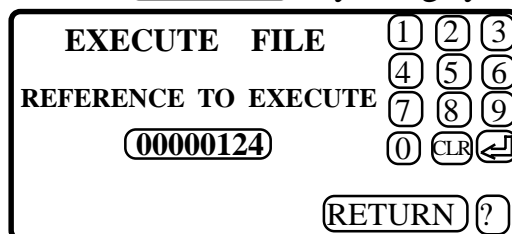

Enter the moulding number and confirm with **↵**



PLEASE , USE THE BUNG  
 WHITE TRIANGLE  
 WITH THIS MOULDING  
 Touch the screen to continue

The CS4095 will request you to put the memorised top pressor pad on the machine. Press anywhere on the screen to continue.

Moulding :	00000124	1	2	3
Width :	011	4	5	6
POSITION	1 005 2 00 3 00	7	8	9
SIZE	7 5 5	0	CLR	↩
NUMBER	1 0 0			
		EXECUTE		RETURN
				↓

A new screen with all joining parameters for this moulding will appear. Press **EXECUTE** .

MOULDING :	00000124	Fine Tune	
EXECUTION		- 1 mm	+ 1mm
	<b>MANUAL</b>		
Moulding Width	011	<b>SPACER</b>	
Position	1 005 2 000 3 000		
Taille	7 5 5		
Nombre	1 0 0		
<b>PUSHER</b>		45°	RETURN
			?

The machine will immediately prepare itself to join this moulding. If the spacer bars were memorised for this profile number, there will be additional gap on the machine so to put the spacers behind the mouldings.

The machine offers two modes of joining: **MANUAL** or **AUTOMATIC**

The CS4095 always proposes first the Manual mode. Pressing the key **MANUAL**, you change it **AUTOMATIC** mode or the opposite way.

**AUTOMATIC mode** : pushing the foot pedal, the machine clamps the mouldings and inserts all the wedges of the joining process.

**MANUAL mode**: pushing the foot pedal, the machine clamps the mouldings. To insert the wedges, press the (black) stapling button. (There are 3 manual modes possible. This is set up in the Function parameters of the machine. See the first pages of the instructions manual).

**Both in AUTOMATIC and MANUAL modes, the foot pedal must remain pushed during the whole joining cycle.**

**PUSHER** key allows you to correct, if you detect a bad loading of the cartridge into the distributor head. The FINE TUNE keys allow you to adapt the CS4095 to the changes of the moulding width (up to +/- 2 mm) from the memorised standard width.

Pressing the **(45°)** key, you can adapt the machine to join 6-sided (cut at 30°) or 8-sided (cut at 22,5°) frames with the same mouldings. (You need to insert special angle attachments in front of the sliding table. These attachments are available for CS4095 as optional accessories). When joining 6 or 8-sided frames, we advise not to use the spacer bars so not to lose capacity in terms of maximum width of moulding to be joined.

Please note the following limitations for 6 - 8 sided frames:

	<b>Moulding width maximum</b>	<b>Minimum distance of the wedge</b>
6-sided ( 30° )	120mm (app rox. <b>4" 7/8</b> )	3mm from rebate
8-sided (22.5°)	115mm (approx. <b>4" 5/8</b> )	7mm from rebate

## (2) EXECUTE DIRECTLY:

This execution mode allows the operator to join mouldings without recording in FILE memory. In this mode, the machine reminds automatically the joining process of the last moulding executed which allows the operator to go on any series production after shutting down the machine for a while, without calling up the moulding reference again.

In this mode, it is also possible to modify some joining parameters for a moulding in file at the time of execution, without modifying the parameters memorised in file. This mode permits the operator also to find a moulding number in the articles list (JOINING FILE + MODIFY+ LIST OF ARTICLES), to come back and execute it immediately in the direct mode.

## 5 ) EXAMPLE AND ENTRY OF AN ARTICLE WITH 3 STAPLING POINTS

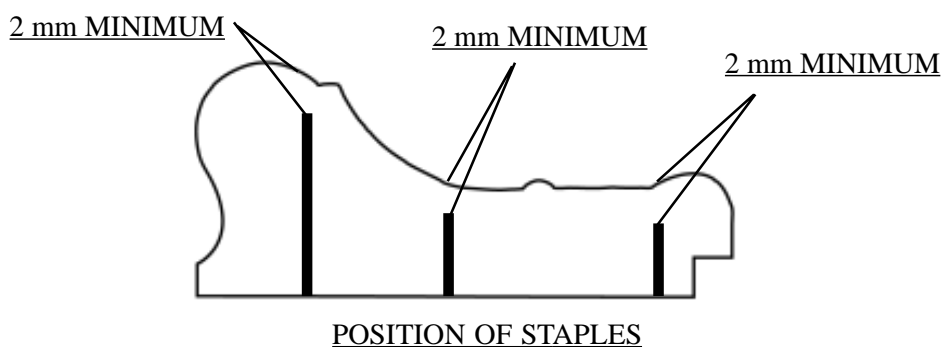

Because of its width, this moulding will be assembled with 3 stapling points, located on the highest portions. The 2 mm rule gives us the maximum penetration heights.

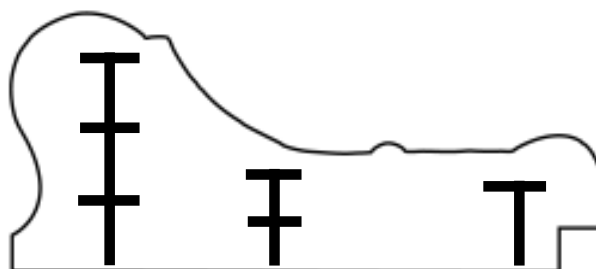

As the staples must penetrate to at least 2/3 of each height, here is the size and number of staples to be used for each point, staples of the same size being able to be stacked on each other.

## MEASUREMENT OF THE WIDTH

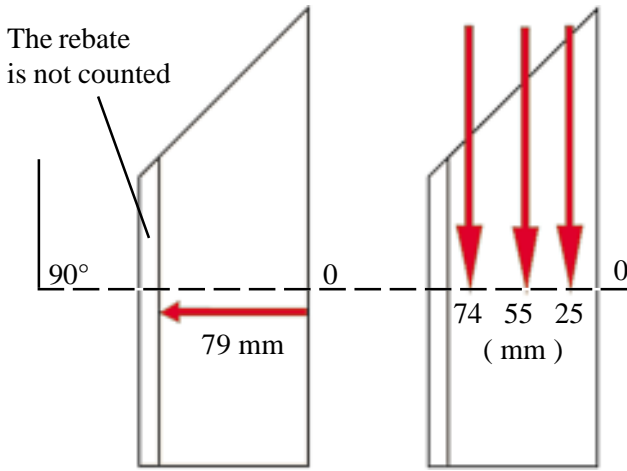

ARTICLE No.	538		
WIDTH	79 mm		
POSITION	25	55	74
WEDGE SIZE	10	7	12
NUMBER OF WEDGES	3	2	1
PRESSER TIP	GREEN 45 mm		
SPACER BARS	NO		

## MEASUREMENT OF THE POSITION OF THE WEDGES

The width of the moulding not counting the rebate, and the position of the wedges are measured in millimetres, perpendicular to and starting from the outside edge of the moulding.

The stapling points are projected perpendicularly onto the line of measurement of the width. The measurement of each point starts from the outside edge up to each intersection with the 45° cut.

Once all the necessary information has been obtained, a table is made up before entry. The article number is totally arbitrary in this example.

REFERENCE TO CREATE	1	2	3
	4	5	6
00000538	7	8	9
	0	CLR	↵
RETURN	?		

On the MAIN MENU, press JOINING FILE, followed by CREATE. Enter the moulding number 538. Confirm with ↵

REFERENCE : 00000538	1	2	3
Moulding Width : 079	4	5	6
GREEN RUBBER 45	7	8	9
SPACER	0	CLR	↵
			↓
PAGE 2	ENTER	RETURN	?

Enter the width of the profile in mm. Confirm with ↵.

Press the window WHITE TRIANGLE until it comes to GREEN RUBBER 45.

As no spacers are needed for this moulding don't press the SPACER key.

Press PAGE 2 to go to page 2

MouldingWidth : 079	1	2	3
POSITION 1 2 3	4	5	6
025 055 074	7	8	9
SIZE 10 7 12	0	CLR	↵
NUMBER 3 2 1			↓
PAGE1	ENTER	RETURN	?

On page 2, enter the values of the positions. After Each value and ↵ key, move to the next value with VERTICAL ARROW. Press SIZE to access to the choice of wedge sizes or each position. Press active position, then wedge size for it. Press ENTER to come back to page 2.

POSITION 1	POSITION 2	POSITION 3		
10	7	12		
WEDGE SELECTION				
5	7	10	12	15
5HW	7HW	10HW	12HW	15HW
SEE BARREL	ENTER	?		

Enter the wedge quantities and confirm with ↵. When all parameters are like on your table for this moulding, press ENTER.

## MODIFICATION D'ARTICLE

<b>CS 4095 MAIN MENU</b>	
MAINTENANCE	EXECUTE
JOINING FILE	CARTRIDGE FILE

<b>FILES MANAGER</b>	
CREATE	
<b>MODIFY</b>	
ERASE	?
	RETURN

On the MAIN MENU , press JOINING FILE , then MODIFY .

<b>REFERENCE TO MODIFY</b>		1 2 3
00000538		4 5 6
		7 8 9
		0 CLR ↵
ARTICLES LIST	RETURN	?

REFERENCE 00000538	1 2 3
Moulding Width : 079	4 5 6
GREEN RUBBER 45	7 8 9
SPACER	0 CLR ↵
	↓
PAGE 2	ENTER RETURN ?

To check the moulding in file , press ARTICLES LIST . Enter the moulding number and confirm with (↵) , to access to first page of joining data of this reference numbers . You can change now any joining parameter of this moulding like in process of recording an article ( page 6 ) .

Moulding Width : 079	1 2 3
POSITION 1 2 3	4 5 6
025 055 074	7 8 9
SIZE 10 10 10	0 CLR ↵
NUMBER 3 1 1	↓
PAGE1	ENTER RETURN ?

POSITION 1	POSITION 2	POSITION 3
10	10	10
WEDGE SELECTION		
5	7	10
12	15	
5HW	7HW	10HW
2HW	15HW	
SEE BARREL	ENTER	?

Enter the new joining parameters on page 1 and 2 and memorise the new parameters with (ENTER) key on page 2 .

## CANCELLATION OF AN ARTICLE

<b>CS 4095 MAIN MENU</b>	
MAINTENANCE	EXECUTE
JOINING FILE	CARTRIDGE FILE

<b>FILES MANAGER</b>	
CREATE	
MODIFY	
ERASE	?
	RETURN

On the MAIN MENU , press (JOINING FILE) , then (ERASE) .

<b>REFERENCE TO ERASE</b>		1 2 3
00000033		4 5 6
		7 8 9
		0 CLR ↵
ARTICLES LIST	RETURN	?

To check the list of mouldings in file , press ARTICLES LIST . Enter the moulding number to be cancelled and confirm with (↵) key . The machine will ask you again if you are sure .

## PRESET FOR VOLUME PRODUCTION

Let us return to article 538.

Its penetration depths have defined the use of 3 sizes of wedge : 10, 12 and 7 mm.

ARTICLE No.	538		
WIDTH	79 mm		
POSITION	25	55	74
WEDGE SIZE	10	7	12
NUMBER OF WEDGES	3	2	1
TOP PRESSER TYPE	GREEN 45 mm		
SPACER BARS	NO		

We now wish to create an article 539, identical to article 538 but only using one size of wedge, the 10 mm size, which gives sufficient penetration:

ARTICLE No.	539		
WIDTH	79 mm		
POSITION	25	55	74
WEDGE SIZE	10	10	10
NUMBER OF WEDGES	3	2	1
TOP PRESSER TYPE	GREEN 45 mm		
SPACER BARS	NO		

The difference between these two articles is therefore the NUMBER and the SIZE of wedges.

Let us execute these two articles, in MANUAL MODE, timing how long it takes for each to assemble a corner .

Results:                      **Article 538 takes 9.3 seconds.**  
   **Article 539 takes 4 seconds.**

This demonstration enables us to conclude that the best productivity is obtained by the use of a minimum number of wedge sizes for the assembly. For the mass production of frames, the barrel of the CS 4095 may be loaded entirely with wedges of the same size.

## SCREEN MESSAGES

There is a continuous help function on the CS 4095, which can be accessed either at your request by pressing the (?) button or if there is an incident or a programming error. For example:

File number 00000666  
DOES NOT EXIST  
DO YOU WANT TO CREATE IT?

YES NO

The CS 4095 is informing you that the article number that you have entered for execution is not referenced.

ONE OR MORE CARTRIDGES  
SIZE 5 c1 EMPTY  
ARE EMPTY . c2 7  
c3 10  
c4 12  
c5 15  
LOAD BARREL

The CS 4095 has detected the absence of wedges in one or more cartridges , warns you about this and helps you to replace them.

INSUFFICIENT PRESSURE  
There is no enough pressure air  
for the machine to work normally  
check the air arrival . Once the problem  
is solved , the machine comes back to  
the last screen .

The CS 4095 cannot operate without compressed air.  
Check the following:

- That the air valve is open,
- The connection to the pressure reducer,
- The output from the compressor,
- The operation of the compressor.

**WARNING !!!**  
CLAMPING SAFETY ACTIVATED !  
Either there are no muoldings on the  
machine or the moulding width is far  
from the standard width of this  
moulding number .

The CS 4095 is fitted with an end of run detector for the clamp, so that stapling is stopped if there are no mouldings. If the message appears when there are mouldings in place on the machine, the fault could be because:

- The pressure of the clamp is too strong compared to the hardness of the moulding:

Use the button for adjusting the pressure of the clamp.  
- The dimensions of the moulding are smaller than those recorded in the article that has been loaded.

BARREL DISPLAY

c1 5  
c2 7  
c3 10  
c4 12  
c5 15  
RETURN

The types of cartridges loaded in the CS 4095 may be easily checked ,visually on the screen. The cartridge to be used may then be selected.

..... And many other screen messages help and advise the operator during all the steps of CS 4095's function .

# MAINTENANCE

**BEFORE ANY INTERVENTION,  
UNPLUG THE POWER SUPPLY AND CLOSE THE AIR VALVE**

## 1) LUBRICATION

From time to time, remove the wedge distributor (block H ) and clean it (by air) without dismantling it. It is recommended that you grease the hammer periodically.

To do this, block H must be removed, and a small quantity of grease is then put in the housing of the hammer at the base of block H.

If the top plunger slides with difficulty, oil the horizontal axes, using SAE 20/40 oil.

## 2) CLEARING OF A WEDGE STUCK IN THE DISTRIBUTOR

### INCIDENT IN WEDGES INSERTION !!!

STOP THE MACHINE AND CHECK IF THERE  
ARE NO WEDGES JAMMED IN WEDGE  
DISTRIBUTION BLOCK.

During assembly, one or more wedges may get stuck in the distributor. The CS 4095 will then display the message opposite.

- Switch off the power and close the air valve.
- Try to remove the cartridge that is in position. If it resists, use the wedge removal tool to replace the wedge in the cartridge.
- The wedge remover must not penetrate more than 6 mm ( 1/4" ) into the distributor.
- In case of hammer and wedge jamming, see the following section (3).

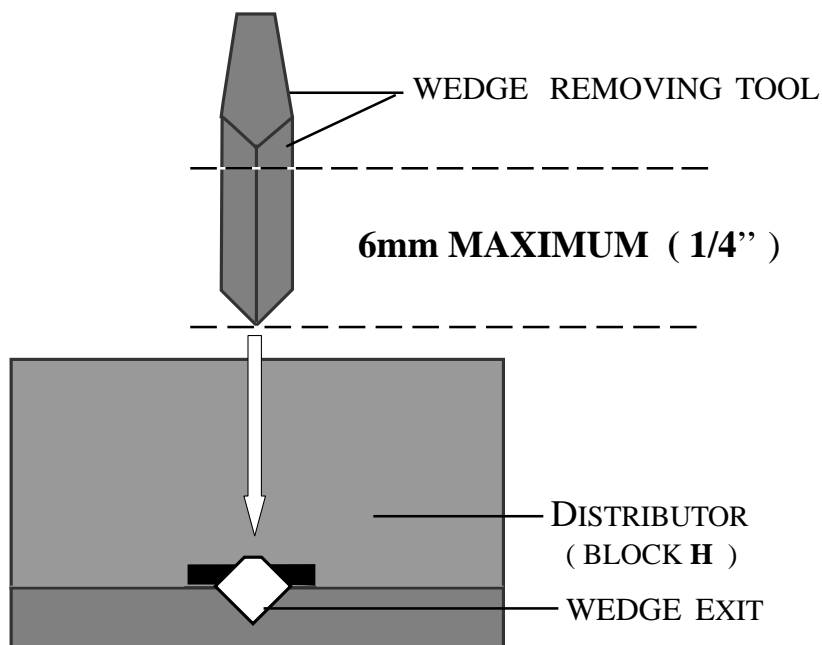

# MAINTENANCE

**BEFORE ANY INTERVENTION,  
UNPLUG THE POWER SUPPLY AND CLOSE THE AIR VALVE**

## **3 ) IN CASE OF A WEDGE JAMMING**

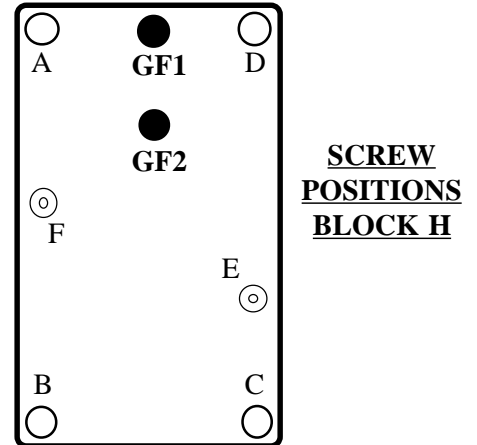
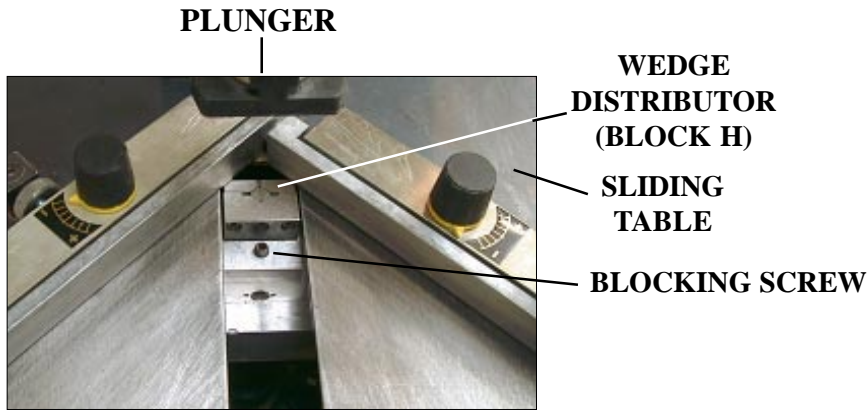

Remove the cartridge that is in position in the active channel by moving the barrel so that it stands sufficiently out of the machine's structure.

Loosen the blocking screw of Block H with the 3mm Allen key.

Next, lift the plunger. The wedge distributor (block H) will come out of its housing.

Remove it from the machine.

**The hammer (wedge driver blade) jammed in the block H,** try to remove it with a pair of pliers. If not possible, unscrew the 2 central screws (GF1 & GF2) that hold the fixed (square) guide of Block H in place. Use for this the smaller (2.5mm) Allen key supplied with the machine. Remove the fixed guide completely to free the old hammer. If still not possible to get rid of the old hammer, remove the 4 screws (A,B,C,D) and open the block H. (Two factory set locator pins E & F allow the plates to be re-positioned precisely again),

Remove the old hammer. Assemble the block H back again.

### **Putting a new hammer:**

Put a drop of grease (tube of grease supplied with the machine) in the bottom hole of the wedge distributor (block H).

Insert a new hammer into the wedge distributor from the top, with the hole of the hammer downwards.

Re-position the wedge distributor in its housing on the machine with the window towards the cartridge.

If the upper end of the hammer stays out of the block H, push it fully in with a piece of wood or moulding.

Now turn on the power and air supply to the machine.

On the MAIN MENU, press **MAINTENANCE**

Then press NEXT, on the next two screens.



You will get the following screen:

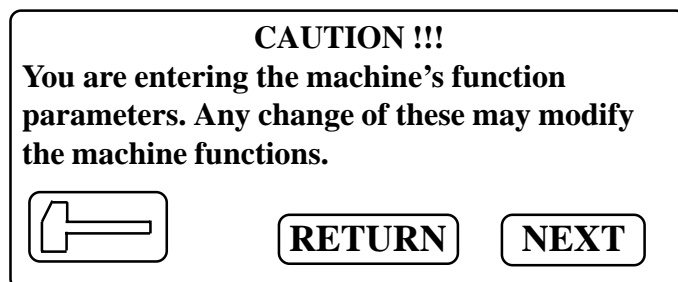

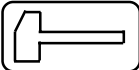
Press on key  which symbolises a hammer.

The machine is ready for hammer change and the following screen comes up:

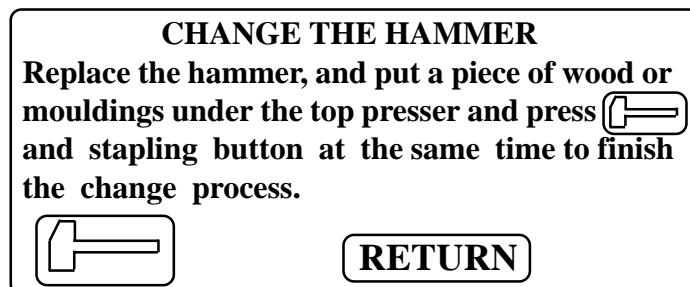

Put any of the top presser ends (triangle or round rubber) on the machine and place a big piece of wood (hardwood is better) on the block H, on the machine. (Maxi distance between the top presser and the moulding must be 50mm (2").)

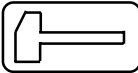
Now, keeping -key pressed on the machine, push the stapling (black) button at the same time; the machine will simulate a wedge insertion so that the new hammer can take its position in the mechanism automatically.

Press on  on the screen.

Now, turn off the machine from the power and air supply.

Tighten the blocking screw of the block H, using the 3mm Allen key (supplied with the machine). No need to tighten too much.

Now the machine is ready to work again.

**AFTER ANY INCIDENT, IF THE HAMMER REMAINS  
IN BLOCK H , YOU MUST CHANGE IT.**